

## DIGITAL HD PLAYER

# CU-VH1

Please visit our Homepage on the World Wide Web for Digital Video Camera:

<http://www.jvc.co.jp/english/cyber/>

For Accessories:

<http://www.jvc.co.jp/english/accessory/>

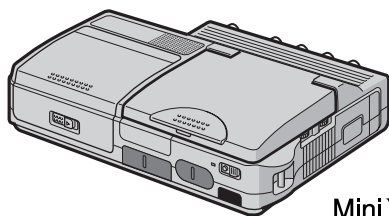

Mini **DV** NTSC

## INSTRUCTIONS

### For Customer Use:

Enter below the Model No. and Serial No. which is located on the bottom of the player. Retain this information for future reference.

**Model No.**

**Serial No.**

<i>GETTING STARTED</i>	<i>11</i>
<i>VIDEO PLAYBACK</i>	<i>18</i>
<i>DIGITAL STILL CAMERA (D.S.C.) PLAYBACK</i>	<i>22</i>
<i>ADVANCED FEATURES</i>	<i>28</i>
<i>REFERENCES</i>	<i>44</i>
<i>TERMS</i>	<i>61</i>

**Dear Customer,**

Thank you for purchasing this digital HD player. Before use, please read the safety information and precautions contained in the following pages to ensure safe use of this product.

**Using This Instruction Manual**

- All major sections are listed in the Table Of Contents on the cover page.
- Notes appear after most subsections. Be sure to read these as well.
- Basic and advanced features/operation are separated for easier reference.

**It is recommended that you...**

- ... refer to the Index (☞ pg. 58 – 60) and familiarize yourself with button locations, etc. before use.
- ... read thoroughly the Safety Precautions and Safety Instructions that follow. They contain extremely important information regarding the safe use of this product.

You are recommended to carefully read the cautions on pages 52 through 54 before use.

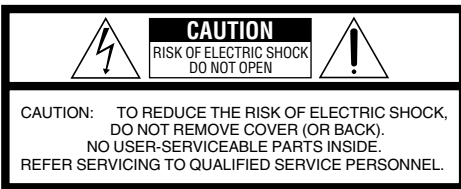
**SAFETY PRECAUTIONS**

The lightning flash with arrowhead symbol, within an equilateral triangle, is intended to alert the user to the presence of uninsulated "dangerous voltage" within the product's enclosure that may be of sufficient magnitude to constitute a risk of electric shock to persons.



The exclamation point within an equilateral triangle is intended to alert the user to the presence of important operating and maintenance (servicing) instructions in the literature accompanying the appliance.

The AA-V40U AC Power Adapter/Charger should be used with:

AC 120 V~, 60 Hz in the USA and Canada, AC 110 V - 240 V~, 50 Hz/60 Hz in other countries.

**CAUTION (applies to the AA-V40U)**

TO PREVENT ELECTRIC SHOCK MATCH WIDE BLADE OF PLUG TO WIDE SLOT, FULLY INSERT.

**ATTENTION (s'applique à l'AA-V40U)**

POUR ÉVITER LES CHOCS ÉLECTRIQUES, INTRODUIRE LA LAME LA PLUS LARGE DE LA FICHE DANS LA BORNE CORRESPONDANTE DE LA PRISE ET POUSSER JUSQU'AU FOND.

**WARNING:**

**TO PREVENT FIRE OR SHOCK HAZARD, DO NOT EXPOSE THIS UNIT TO RAIN OR MOISTURE.**

**NOTES:**

- The rating plate (serial number plate) and safety caution are on the bottom and/or the back of the main unit.
- The rating plate (serial number plate) of the AC Power Adapter/Charger is on its bottom.

**CAUTIONS:**

- This player is designed to be used with NTSC-type color television signals. It cannot be used for playback with a television of a different standard. However, LCD monitor playback is possible anywhere.
- Use the JVC BN-V416U/V428U battery packs and, to recharge them or supply power to the player from an AC outlet, use the provided multi-voltage AC Power Adapter/Charger. (An appropriate conversion adapter may be necessary to accommodate different designs of AC outlets in different countries.)

When the equipment is installed in a cabinet or on a shelf, make sure that it has sufficient space on all sides to allow for ventilation (10 cm (3-15/16") or more on both sides, on top and at the rear).

Do not block the ventilation holes.

(If the ventilation holes are blocked by a newspaper, or cloth etc. the heat may not be able to get out.)

No naked flame sources, such as lighted candles, should be placed on the apparatus.

When discarding batteries, environmental problems must be considered and the local rules or laws governing the disposal of these batteries must be followed strictly.

The apparatus shall not be exposed to dripping or splashing.

Do not use this equipment in a bathroom or places with water.

Also do not place any containers filled with water or liquids (such as cosmetics or medicines, flower vases, potted plants, cups etc.) on top of this unit.

(If water or liquid is allowed to enter this equipment, fire or electric shock may be caused.)

This product has a fluorescent lamp that contains a small amount of mercury. Disposal of these materials may be regulated in your community due to environmental considerations.

For disposal or recycling information please contact your local authorities, or the Electronics Industries Alliance:

<<http://www.eiae.org>>

# IMPORTANT PRODUCT SAFETY INSTRUCTIONS

Electrical energy can perform many useful functions. But improper use can result in potential electrical shock or fire hazards. This product has been engineered and manufactured to assure your personal safety. In order not to defeat the built-in safeguards, observe the following basic rules for its installation, use and servicing.

## ATTENTION:

Follow and obey all warnings and instructions marked on your product and its operating instructions. For your safety, please read all the safety and operating instructions before you operate this product and keep this manual for future reference.

## INSTALLATION

### 1. Grounding or Polarization

(A) Your product may be equipped with a polarized alternating-current line plug (a plug having one blade wider than the other). This plug will fit into the power outlet only one way. This is a safety feature.

If you are unable to insert the plug fully into the outlet, try reversing the plug. If the plug should still fail to fit, contact your electrician to replace your obsolete outlet. Do not defeat the safety purpose of the polarized plug.

(B) Your product may be equipped with a 3-wire grounding-type plug, a plug having a third (grounding) pin. This plug will only fit into a grounding-type power outlet. This is a safety feature.

If you are unable to insert the plug into the outlet, contact your electrician to replace your obsolete outlet. Do not defeat the safety purpose of the grounding-type plug.

### 2. Power Sources

Operate your product only from the type of power source indicated on the marking label. If you are not sure of the type of power supply to your home, consult your product dealer or local power company. If your product is intended to operate from battery power, or other sources, refer to the operating instructions.

### 3. Overloading

Do not overload wall outlets, extension cords, or integral convenience receptacles as this can result in a risk of fire or electric shock.

### 4. Power Cord Protection

Power supply cords should be routed so that they are not likely to be walked on or pinched by items placed upon or against them, paying particular attention to cords at plugs, convenience receptacles, and the point where they exit from the product.

### 5. Ventilation

Slots and openings in the cabinet are provided for ventilation. To ensure reliable operation of the product and to protect it from overheating, these openings must not be blocked or covered.

- Do not block the openings by placing the product on a bed, sofa, rug or other similar surface.
- Do not place the product in a built-in installation such as a bookcase or rack unless proper ventilation is provided or the manufacturer's instructions have been adhered to.

### 6. Wall or Ceiling Mounting

The product should be mounted to a wall or ceiling only as recommended by the manufacturer.

## ANTENNA INSTALLATION INSTRUCTIONS

### 1. Outdoor Antenna Grounding

If an outside antenna or cable system is connected to the product, be sure the antenna or cable system is grounded so as to provide some protection against voltage surges and built-up static charges. Article 810 of the National Electrical Code, ANSI/NFPA 70, provides information with regard to proper grounding of the mast and supporting structure, grounding of the lead-in wire to an antenna discharge unit, size of grounding conductors, location of antenna discharge unit, connection to grounding electrodes, and requirements for the grounding electrode.

### 2. Lightning

For added protection for this product during a lightning storm, or when it is left unattended and unused for long periods of time, unplug it from the wall outlet and disconnect the antenna or cable system. This will prevent damage to the product due to lightning and power-line surges.

### 3. Power Lines

An outside antenna system should not be located in the vicinity of overhead power lines or other electric light or power circuits, or where it can fall into such power lines or circuits. When installing an outside antenna system, extreme care should be taken to keep from touching such power lines or circuits as contact with them might be fatal.

**EXAMPLE OF ANTENNA GROUNDING AS PER NATIONAL ELECTRICAL CODE, ANSI/NFPA 70**

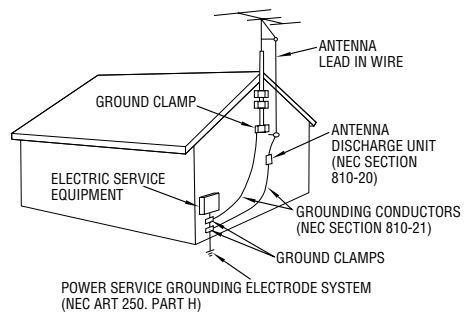

NEC - NATIONAL ELECTRICAL CODE

## USE

### 1. Accessories

#### To avoid personal injury:

- Do not place this product on an unstable cart, stand, tripod, bracket or table. It may fall, causing serious injury to a child or adult, and serious damage to the product.
- Use only with a cart, stand, tripod, bracket, or table recommended by the manufacturer or sold with the product.
- Use a mounting accessory recommended by the manufacturer and follow the manufacturer's instructions for any mounting of the product.
- Do not try to roll a cart with small casters across thresholds or deep-pile carpets.

### 2. Product and Cart Combination

A product and cart combination should be moved with care. Quick stops, excessive force, and uneven surfaces may cause the product and cart combination to overturn.

**PORTABLE CART WARNING**  
(Symbol provided by RETAC)



### 3. Water and Moisture

Do not use this product near water-for example, near a bath tub, wash bowl, kitchen sink or laundry tub, in a wet basement, or near a swimming pool and the like.

### 4. Object and Liquid Entry

Never push objects of any kind into this product through openings as they may touch dangerous voltage points or short-out parts that could result in a fire or electric shock. Never spill liquid of any kind on the product.

### 5. Attachments

Do not use attachments not recommended by the manufacturer of this product as they may cause hazards.

### 6. Cleaning

Unplug this product from the wall outlet before cleaning. Do not use liquid cleaners or aerosol cleaners. Use a damp cloth for cleaning.

### 7. Heat

The product should be situated away from heat sources such as radiators, heat registers, stoves, or other products (including amplifiers) that produce heat.

## SERVICING

### 1. Servicing

If your product is not operating correctly or exhibits a marked change in performance and you are unable to restore normal operation by following the detailed procedure in its operating instructions, do not attempt to service it yourself as opening or removing covers may expose you to dangerous voltage or other hazards. Refer all servicing to qualified service personnel.

### 2. Damage Requiring Service

Unplug this product from the wall outlet and refer servicing to qualified service personnel under the following conditions:

- When the power supply cord or plug is damaged.
- If liquid has been spilled, or objects have fallen into the product.
- If the product has been exposed to rain or water.
- If the product does not operate normally by following the operating instructions. Adjust only those controls that are covered by the operating instructions as an improper adjustment of other controls may result in damage and will often require extensive work by a qualified technician to restore the product to its normal operation.
- If the product has been dropped or damaged in any way.
- When the product exhibits a distinct change in performance-this indicates a need for service.

### 3. Replacement Parts

When replacement parts are required, be sure the service technician has used replacement parts specified by the manufacturer or have the same characteristics as the original part. Unauthorized substitutions may result in fire, electric shock or other hazards.

### 4. Safety Check

Upon completion of any service or repairs to this product, ask the service technician to perform safety checks to determine that the product is in safe operating condition.

## SAFETY PRECAUTIONS

### CAUTION!

The following notes concern possible physical damage to the player and to the user.

When carrying, be sure to always securely attach and use the provided strap. Carrying or holding the player by the LCD monitor can result in dropping the unit, or in a malfunction.

Take care not to get your finger caught in the cassette holder cover. Do not let children operate the player, as they are particularly susceptible to this type of injury.

### CAUTION!

Connecting cables (S, audio/video, USB, etc.) to the player and leaving it on top of the TV is not recommended, as tripping on the cables will cause the player to fall, resulting in damage.



- This player is designed exclusively for the digital video cassette, SD Memory Card and MultiMediaCard. Only cassettes marked "Mini DV" and memory cards marked "SD" or "MultiMediaCard" can be used with this unit.

### Before using the player...

- ... make sure you only use cassettes with the Mini DV mark .
- ... make sure you only use memory cards with the mark  or *MultiMediaCard*.
- ... remember that this player is not compatible with other digital video formats.
- ... remember that this player is intended for private consumer use only. Any commercial use without proper permission is prohibited. (Even if you record an event such as a show, performance or exhibition for personal enjoyment, it is strongly recommended that you obtain permission beforehand.)

## Provided Accessories



AC Power Adapter/  
Charger AA-V40U

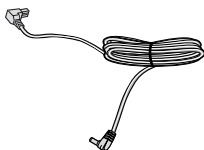

DC Cord

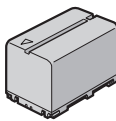

Battery Pack  
BN-V416U



Audio/Video Cable  
(RCA plug to RCA plug)



S-Video Cable

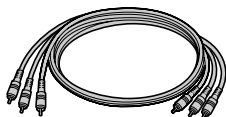

Component Video Cable

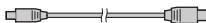

USB Cable



Audio Cable x 2  
(for connection of  
optional headphones  
and external microphone  
☞ pg. 9)

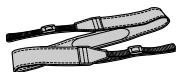

Shoulder Strap  
(☞ pg. 9 for attachment)

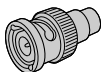

RCA-BNC Adapter x 3

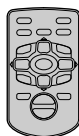

Remote Control Unit  
RM-V718U



Lithium Battery CR2025\*  
(for remote control unit)  
\* A lithium battery is pre-  
installed in the Remote  
Control Unit at time of  
shipment (with  
insulation sheet). To use  
the Remote Control  
Unit, remove the  
insulation sheet.

Core Filter  
(☞ pg. 8 for attachment)

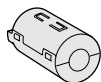

- Large (A) x 2



- Large (B) x 1
- Medium x 2
- Small x 3

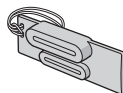

Connector Cover

### NOTES:

- In order to maintain optimum performance of the player, provided cables may be equipped with one or more core filter. If a cable has only one core filter, the end that is closest to the filter should be connected to the player.
- Make sure to use the provided cables for connections. Do not use any other cables.

## How To Attach The Core Filter

Attach the core filters to the cables. The core filter reduces interference.

### Types of core filters

Size	Cable	Times to wind
Large (A)	Audio/video cable	Once
	S-video cable	
Large (B)	i.LINK cable*	Twice
Medium	USB cable**	Once
Small	DC cord	Once
	Audio cable	

\* Optional  
(If you have an optional JVC i.LINK cable VC-VDV206U or VC-VDV204U with core filters, it is not necessary to attach the provided core filter. If you are going to use any other i.LINK cable, attach the provided core filter.)

\*\* Attach two core filters to both ends of the cable.

The procedure below is an example of winding cable once.

- 1 Release the stoppers on both ends of the core filter.

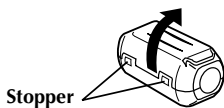

- 2 Run the cable through the core filter, leaving approx. 3 cm of cable between the cable plug and the core filter. Wind the cable once around the outside of the core filter as shown in the illustration.

- Wind the cable so that it is not slack.

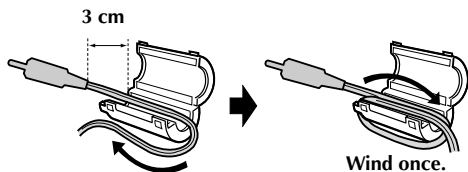

- 3 Close the core filter until it clicks shut.

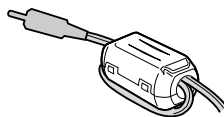

### NOTES:

- Take care not to damage the cable.
- When connecting a cable, attach the end with the core filter to the player.



## How To Attach The Strap

- 1 Thread the strap through the eyelet ①.
- 2 Fold it back and thread it through the strap guide and the buckle.
  - To adjust the length of the strap, loosen and then tighten the strap in the buckle.
- 3 Repeat the procedure to attach the other end of the strap to the other eyelet ②.
- 4 Confirm the strap is not twisted.

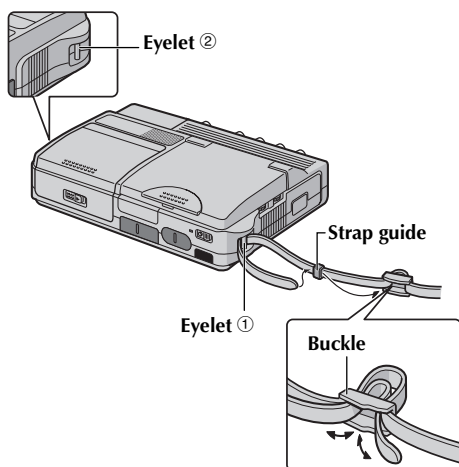

## How To Attach The Connector Cover

To protect the connectors, attach the provided connector cover to the rear panel of the player when the player is not in use.

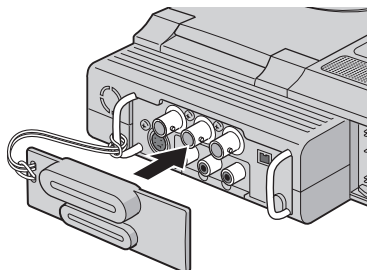

## How To Use The Audio Cable

When using optional headphones or external microphone, connect to the provided audio cable (with a core filter attached), then connect the audio cable to the player. The core filter reduces interference.

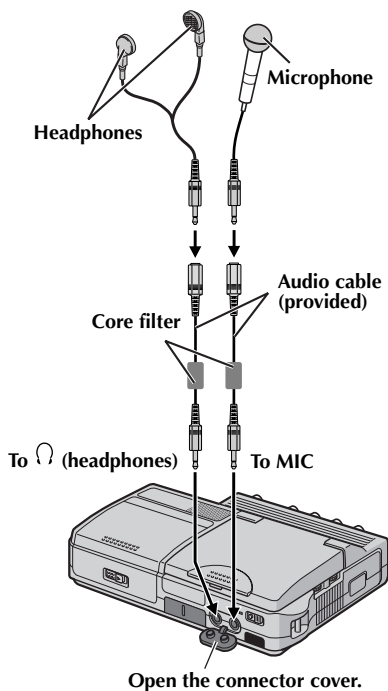

<b>GETTING STARTED</b>	<b>11</b>	<b>REFERENCES</b>	<b>44</b>
Power .....	11	<b>DETAILS</b> .....	<b>44</b>
Operation Mode .....	13	<b>TROUBLESHOOTING</b> .....	<b>45</b>
LCD Monitor .....	14	<b>CAUTIONS</b> .....	<b>52</b>
Brightness Adjustment Of The Display .....	14	<b>USER MAINTENANCE</b> .....	<b>55</b>
Date/Time Settings .....	15	<b>SPECIFICATIONS</b> .....	<b>56</b>
Loading A Cassette		<b>INDEX</b> .....	<b>58</b>
/Unloading A Cassette .....	16		
Loading A Memory Card		<b>TERMS</b>	<b>61</b>
/Unloading A Memory Card .....	17		
<b>VIDEO PLAYBACK</b>	<b>18</b>		
Normal Playback .....	18		
Still Playback .....	18		
Frame-By-Frame Playback .....	18		
Shuttle Search .....	19		
Blank Search .....	19		
Connections To A TV Or VCR .....	20		
<b>DIGITAL STILL CAMERA (D.S.C.) PLAYBACK</b>	<b>22</b>		
Normal Playback Of Images .....	22		
Auto Playback Of Images .....	22		
Index Playback Of Files .....	23		
Viewing File Information .....	23		
Removing On-Screen Display .....	23		
Protecting Files .....	24		
Deleting Files .....	25		
Resetting The File Name .....	26		
Setting Print Information (DPOF Setting) .....	26		
Initializing A Memory Card .....	27		
<b>ADVANCED FEATURES</b>	<b>28</b>		
<b>MENUS FOR DETAILED ADJUSTMENT</b> .....	<b>28</b>		
Changing The Menu Settings .....	28		
<b>PLAYBACK MENUS</b> .....	<b>29</b>		
<b>NAVIGATION</b> .....	<b>32</b>		
NAVIGATION Function .....	32		
<b>DUBBING</b> .....	<b>34</b>		
Dubbing To Or From A VCR .....	34		
Dubbing To Or From A Video Unit Equipped With			
An i.LINK Connector (Digital Dubbing) .....	35		
Recording From The Middle Of A Tape .....	36		
Dubbing Still Images Recorded On A Tape To			
A Memory Card .....	38		
<b>USING THE REMOTE CONTROL UNIT</b> .....	<b>39</b>		
Audio Dubbing (DV mode only) .....	42		
<b>SYSTEM CONNECTIONS</b> .....	<b>43</b>		
Connection To A Personal Computer .....	43		

## Power

This player's 2-way power supply system lets you choose the most appropriate source of power. Do not use provided power supply units with other equipment.

### Charging The Battery Pack

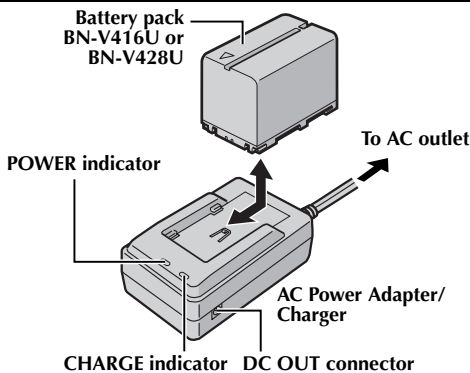

- 1 Make sure you unplug the player's DC cord from the AC Power Adapter/Charger.
- 2 Plug the AC Power Adapter/Charger's power cord into an AC outlet. The POWER indicator lights.
- 3 Attach the battery pack with the ⊕⊖ mark aligned with the corresponding marks on the AC Power Adapter/Charger. The CHARGE indicator begins blinking to indicate charging has started.
- 4 When the CHARGE indicator stops blinking but stays lit, charging is finished. Remove the battery pack.
- 5 Unplug the AC Power Adapter/Charger's power cord from the AC outlet.

Battery pack	Charging time
BN-V416U*	Approx. 2 hr.
BN-V428U	Approx. 3 hr. 20 min.

\* Provided

#### NOTES:

- If the protective cap is attached to the battery pack, remove it first.
- If you connect the player's DC cord to the AC Power Adapter/Charger during battery charging, power is supplied to the player and charging stops.
- Charging is not possible if the wrong type of battery is used.
- When charging the battery pack for the first time or after a long storage period, the CHARGE indicator may not light. In this case, remove the battery pack from the AC Power Adapter/Charger, then try charging again.

- If the battery operation time remains extremely short even after having been fully charged, the battery is worn out and needs to be replaced. Please purchase a new one.
- For other notes, see pg. 44.

### Using The Battery Pack

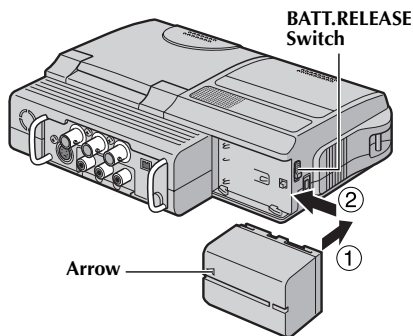

- 1 With the arrow on the battery pack pointing to the left, push the battery pack slightly against the battery pack mount ①.
- 2 Slide the battery pack to the left until it locks in place ②.

#### To detach the battery pack...

Slide the battery pack to the right slightly while sliding **BATT. RELEASE** to detach it.

#### NOTES:

- Available time is reduced significantly under the following conditions:
  - The LCD monitor is used repeatedly.
  - The playback mode is engaged repeatedly.
- Before extended use, it is recommended that you prepare enough battery packs to cover 3 times the planned recording time.

#### ATTENTION:

Before detaching the power source, make sure that the player's power is turned off. Failure to do so can result in a player malfunction.

## Using AC Power

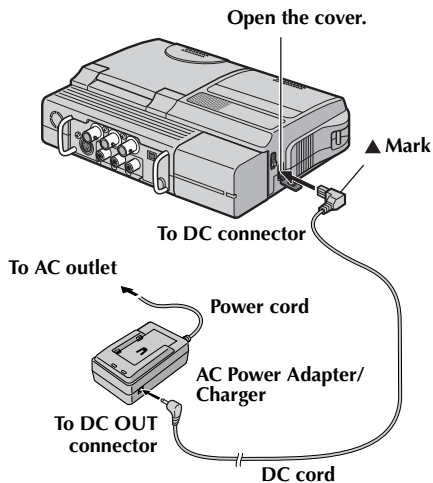

- 1 Make sure you unplug the player's DC cord from the AC Power Adapter/Charger.
- 2 Connect the AC Power Adapter/Charger to the player as shown in the illustration above.

### NOTES:

- The provided AC Power Adapter/Charger features automatic voltage selection in the AC range from 110 V to 240 V.
- For other notes, pg. 44.

## About Batteries

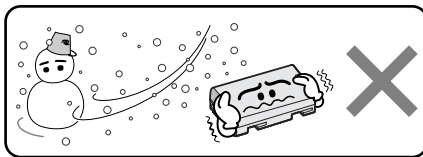

Lithium-ion is vulnerable in colder temperatures.



**DANGER!** Do not attempt to take the batteries apart, or expose them to flame or excessive heat, as it may cause a fire or explosion.

**WARNING!** Do not allow the battery or its terminals to come in contact with metals, as this can result in a short circuit and possibly start a fire.

### The Benefits Of Lithium-Ion Batteries

Lithium-ion battery packs are small but have a large power capacity. However, when one is exposed to cold temperatures (below 10°C/50°F), its usage time becomes shorter and it may cease to function. If this happens, place the battery pack in your pocket or other warm, protected place for a short time, then re-attach it to the player. As long as the battery pack itself is not cold, it should not affect performance. (If you're using a heating pad, make sure the battery pack does not come in direct contact with it.)

For other notes, pg. 44.

## Operation Mode

To turn on the player, set the Power Switch to "ON" while pressing down the Lock Button located on the switch.

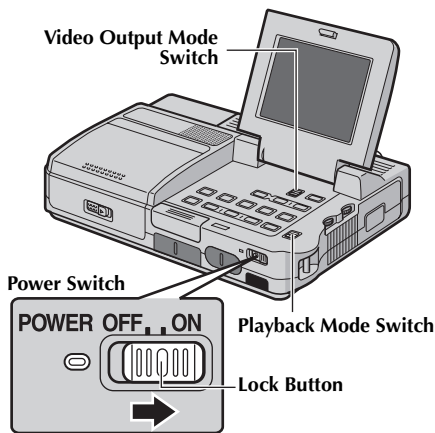

Choose the appropriate operation mode according to your preference using Playback Mode Switch for playback and Video Output Mode Switch for signal output.

### Playback Mode Switch Position

#### VIDEO:

Allows you to play back a tape.

#### MEMORY:

Allows you to play back images stored in a memory card or access data stored in a memory card.

### Video Output Mode Switch Position

#### COMPONENT VIDEO OUT:

Allows you to output signals from the Component Video connector. When you view images on the connected TV, set the switch to this mode. (☞ pg. 20)

#### LCD MONITOR:

When you view images on the player's LCD monitor or TV connected via video or S-video cable, set the switch to this mode.

### Power Switch Position

#### ON:

Allows you to switch on the player.

#### OFF:

Allows you to switch off the player.

## LCD Monitor

Press the Monitor Opening Button and open the LCD monitor fully.  
To view images on the LCD monitor, set the Video Output Mode Switch to "LCD MONITOR".  
(☞ pg. 13)

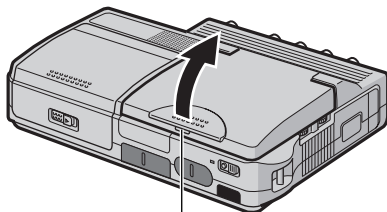

Monitor Opening Button

### NOTES:

- The image on the LCD monitor and the image on the TV screen may look differently in terms of the brightness and color. Confirm the final image on the TV screen.
- Colored bright spots may appear all over the LCD monitor. However, this is not a malfunction.  
(☞ pg. 47)

## Brightness Adjustment Of The Display

- 1 Set the Power Switch to "ON" while pressing down the Lock Button located on the switch.
- 2 Open the LCD monitor fully.
- 3 Rotate the **BRIGHT** Wheel until the appropriate brightness is reached.

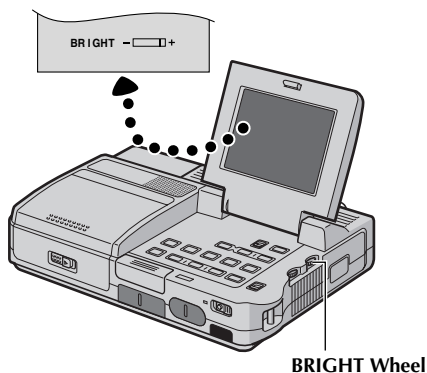

## Date/Time Settings

The date/time display can be turned on or off during playback. (▶ pg. 28, 31)

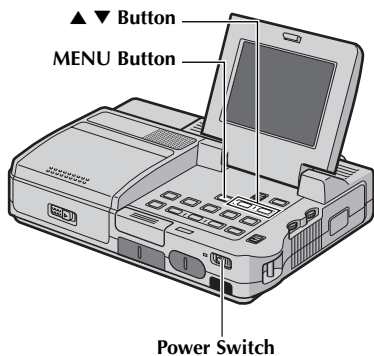

- 1 Set the Power Switch to "ON" while pressing down the Lock Button located on the switch.
- 2 Open the LCD monitor fully.
- 3 Press **MENU**. The Menu Screen appears.

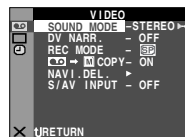

- 4 Press ▲ or ▼ to select "DISPLAY", and press **MENU**. The DISPLAY Menu appears.

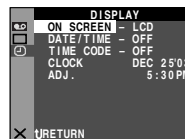

- 5 Press ▲ or ▼ to select "CLOCK ADJ.", and press **MENU**. The parameter for "Month" is highlighted.

- 6 Press ▲ or ▼ to input the month, and press **MENU**. Repeat to input the day, year, hour and minute.

- 7 Press ▲ or ▼ to select "URETURN", and press **MENU** twice. The Menu Screen closes.

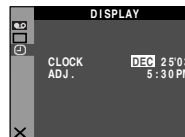

## Loading A Cassette /Unloading A Cassette

The player needs to be powered up to load or eject a cassette

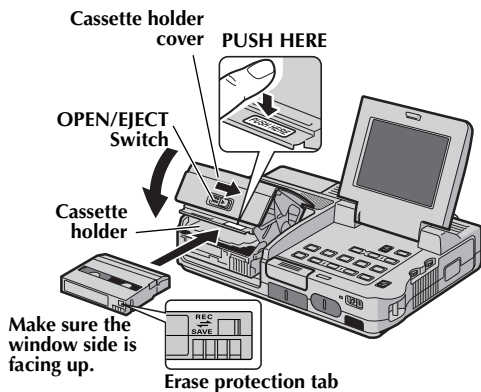

- 1** Slide and hold **OPEN/EJECT** in the direction of arrow, then pull the cassette holder cover open until it locks. The cassette holder opens automatically.
  - Do not touch internal components.
- 2** Insert or remove a tape and press “PUSH HERE” to close the cassette holder.
  - Be sure to press only the section labeled “PUSH HERE” to close the cassette holder; touching other parts may cause your finger to get caught in the cassette holder, resulting in injury or product damage.
  - Once the cassette holder is closed, it recedes automatically. Wait until it recedes completely before closing the cassette holder cover.
  - When the battery pack’s charge is low, you may not be able to close the cassette holder cover. Do not apply force. Replace the battery pack with a fully charged one or use AC power before continuing.
- 3** Close the cassette holder cover firmly until it locks into place.

### To protect valuable recordings...

Slide the erase protection tab on the back of the tape in the direction of “SAVE”. This prevents the tape from being recorded over. To record on this tape, slide the tab back to “REC” before loading it.

### Approximate recording time

Tape	Recording mode	
	SP	LP
30 min.	30 min.	45 min.
60 min.	60 min.	90 min.
80 min.	80 min.	120 min.

To switch the recording mode, refer to pages 28 and 29.

### NOTES:

- It takes a few seconds for the cassette holder to open. Do not apply force.
- If you wait a few seconds and the cassette holder does not open, close the cassette holder cover and try again. If the cassette holder still does not open, turn the player off then on again.
- If the tape does not load properly, open the cassette holder cover fully and remove the cassette. A few minutes later, insert it again.
- When the player is suddenly moved from a cold place to a warm environment, wait a short time before opening the cassette holder cover.
- Closing the cassette holder cover before the cassette holder recedes may cause damage to the player.
- Even when the player is switched off, a cassette can be loaded or unloaded. After the cassette holder is closed with the player switched off, however, it may not recede. It is recommended to turn the power on before loading or unloading.
- When resuming recording, once you open the cassette holder cover a blank portion will be recorded on the tape or a previously recorded scene will be erased (recorded over) regardless of whether the cassette holder came out or not. See “Recording From The Middle Of A Tape” ( pg. 36).



## Loading A Memory Card /Unloading A Memory Card

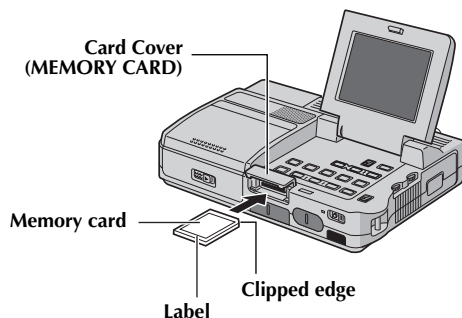

- 1** Make sure the player's power is off.
- 2** Slide to open the card cover (MEMORY CARD).
- 3** **To load a memory card**, firmly insert it with its clipped edge first.  
**To unload a memory card**, push it once. After the memory card comes out of the player, pull it out.
  - Do not touch the terminal on the reverse side of the label.
- 4** Close the card cover.

To protect valuable files (available only for SD Memory Card)...

Write/erase protection tab

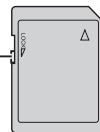

Slide the write/erase protection tab on the side of the memory card in the direction of "LOCK". This prevents the memory card from being recorded over. To record on this memory card, slide the tab back to the position opposite to "LOCK" before loading it.

### NOTES:

- Be sure to use only SD Memory Cards marked "SD" or MultiMediaCards marked "MultiMediaCard".
- Some brands of memory cards are not compatible with this player. Before purchasing a memory card, consult its manufacturer or dealer.
- Before using a new memory card, it is necessary to **FORMAT** the card. (☞ pg. 27)

### ATTENTION:

Do not insert or remove the memory card while the player is turned on, as this may cause the memory card to be corrupted or cause the player to become unable to recognize whether or not the card is installed.

### Information On SD Memory Card

SD Memory Cards up to 64 MB have been verified for use with this player. (As of October 2003)

## Normal Playback

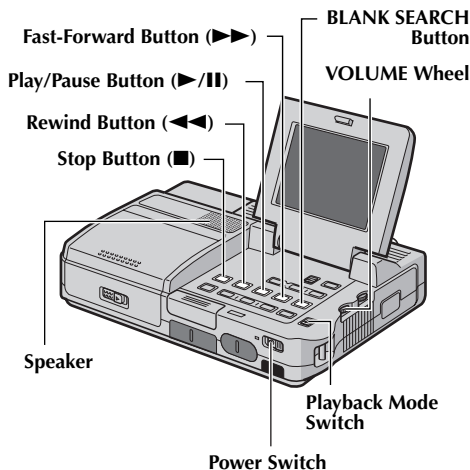

### NOTES:

- Clean the video heads using an optional dry cleaning cassette when:
  - No picture during playback.
  - Blocks of noise appear during playback.
 For details, see pg. 53.
- If Stop mode continues for 5 minutes when power is supplied from a battery, the player shuts off automatically. To turn on again, set the Power Switch to "OFF", then "ON".
- The playback picture can be viewed in the LCD monitor or on a connected TV. (see pg. 20)
- LCD monitor indications:
  - When power is supplied from a battery: the "□" battery indicator is displayed. (see pg. 49)
  - When power is supplied from an AC outlet: the "□" battery indicator does not appear.
- When a cable is connected to the S2, AUDIO (L/R), VIDEO or headphone connector, sound cannot be heard from the speaker.

### To control the speaker volume...

Rotate the **VOLUME** Wheel towards "+" to turn up the volume, or towards "-" to turn down the volume.

## Still Playback

Pauses during video playback.

- 1) Press ▶/|| during playback.
- 2) To resume normal playback, press ▶/|| again.
  - If still playback continues for more than about 3 minutes, the player's Stop mode is automatically engaged.
  - When ▶/|| is pressed, the image may not pause immediately while the player stabilizes the still image.

## Frame-By-Frame Playback

Allows frame-by-frame search during video playback. This feature is available only with a tape recorded in DV recording mode.

- 1) Press ▶/|| during playback.
- 2) Press ▲ for forward and ▼ for reverse.

- 1 Open the LCD monitor fully.
  - Set the Video Output Mode Switch to "LCD MONITOR". (see pg. 13)
- 2 Load a cassette. (see pg. 16)
- 3 Set the Playback Mode Switch to "VIDEO".
- 4 Set the Power Switch to "ON" while pressing down the Lock Button located on the switch.
- 5 To start playback, press ▶/||.
- 6 To stop playback, press ■.
  - During Stop mode, press ◀◀ to rewind, or ▶▶ to fast-forward the tape.

### Maximum continuous playback time

Battery pack	DV mode	HD/SD mode
BN-V416U*	1 hr. 40 min.	1 hr. 30 min.
BN-V428U	3 hr.	2 hr. 50 min.

\* Provided

## Shuttle Search

Allows high-speed search in either direction during video playback.

- 1) During playback, press ►► for forward search, or ◀◀ for reverse search.
- 2) To resume normal playback, press ►/II.
  - During playback, press and hold ►► or ◀◀. The search continues as long as you hold the button. Once you release the button, normal playback resumes.
  - A slight mosaic effect appears on the display during Shuttle Search. This is not a malfunction.

### ATTENTION:

(DV mode only)

During Shuttle Search, parts of the picture may not be clearly visible, particularly on the left side of the screen.



## Blank Search

Helps you find where you should start recording in the middle of a tape to avoid time code interruption.

(☞ pg. 36)

- 1 Load a cassette. (☞ pg. 16)
- 2 Set the Playback Mode Switch to "VIDEO".
- 3 During Stop mode, press **BLANK SEARCH**.
  - The "BLANK SEARCH" indication appears and the player automatically starts reverse or forward search, then stops at the spot which is about 3 seconds of tape before the beginning of the detected blank portion.
  - To cancel Blank Search midway, press ■.

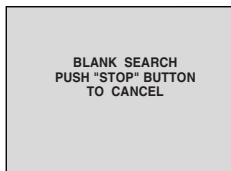

### NOTES:

- Before starting Blank Search, if the current position is at a blank portion, the player searches in the reverse direction. If the current position is at a recorded portion, the player searches in the forward direction.
- Blank Search does not work if "USE CLEANING CASSETTE" has appeared with the tape.
- If the beginning or end of the tape is reached during Blank Search, the player stops automatically.
- A blank portion which is shorter than 5 seconds of tape may not be detected.
- The detected blank portion may be located between recorded scenes. Before you start recording, make sure there is no recorded scene after the blank portion.

## Slow-Motion Playback Playback Zoom

Available only with the remote control (provided).  
(☞ pg. 40, 41)

## Connections To A TV Or VCR

These are some basic types of connections. When making the connections, refer also to your VCR and TV instruction manuals.

### To Connect A Conventional TV or VCR

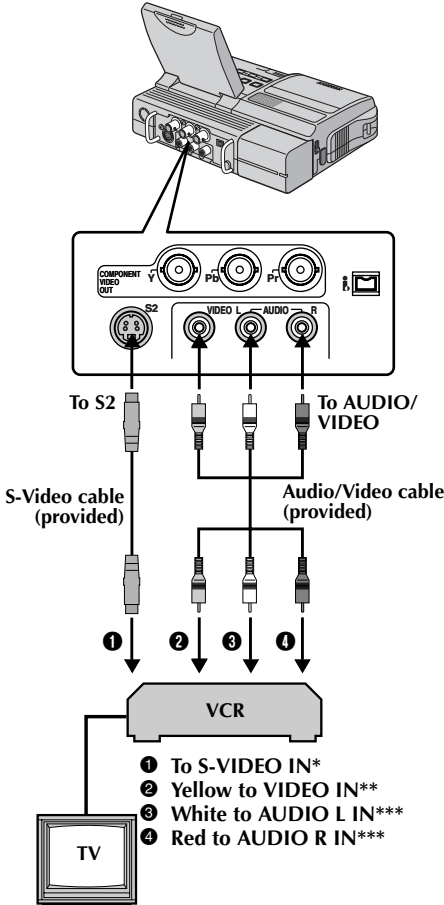

- \* Connect when your TV/VCR has S-VIDEO IN and A/V input connectors. In this case, it is not necessary to connect the yellow video cable.
- \*\* Connect when your TV/VCR has only A/V input connectors.
- \*\*\* Not required for watching still images only.

### To Connect To A TV or VCR Equipped With The Component Video Connectors

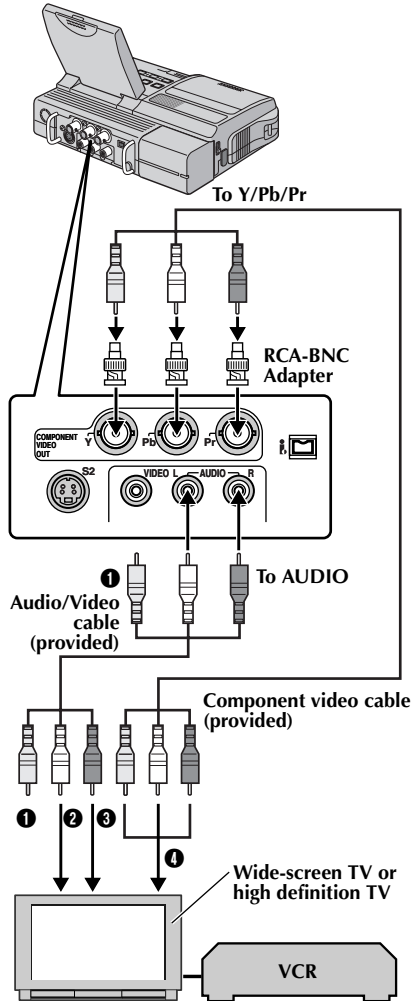

- \* Not required for watching still images only.

- 1** Make sure all units are turned off.
  - 2** Connect the player to a TV or VCR as shown in the illustration.
- If using a VCR**, go to step 3.  
**If not**, go to step 4.
- 3** Connect the VCR output to the TV input, referring to your VCR's instruction manual.
  - 4 For S-video or video connection**  
Set "S/VIDEO" to "16:9 TV" or "4:3 TV" depending on the aspect ratio of the TV you are connecting. (☞ pg. 28, 30)
    - Set the Video Output Mode Switch to "LCD MONITOR".

**For component video connection**

    - Set "Y/Pb/Pr" to any picture size depending on the TV to which you are connecting. (☞ pg. 28, 30)
    - Set the Video Output Mode Switch to "COMPONENT VIDEO OUT".
  - 5** Turn on the VCR and the TV.
  - 6** Set the VCR to its AUX input mode, and set the TV to appropriate input mode.

**To choose whether or not the following displays appear on the connected TV...**

- **Date/Time**  
Set "DATE/TIME" to "AUTO", "ON" or "OFF". (☞ pg. 28, 31)  
Or, press **DISPLAY** on the remote control to turn on/off the date indication.
- **Time Code**  
Set "TIME CODE" to "ON" or "OFF". (☞ pg. 28, 31)
- **Indications other than date/time and time code**  
Set "ON SCREEN" to "OFF", "LCD" or "LCD/TV". (☞ pg. 28, 31)

**NOTES:**

- *It is recommended to use the AC Power Adapter/Charger as the power supply instead of the battery pack.* (☞ pg. 12)
- *Make sure you adjust the TV sound volume to its minimum level to avoid a sudden burst of sound when the player is turned on.*
- *If you have a TV or speakers that are not specially shielded, do not place the speakers adjacent to the TV as interference will occur in the player playback picture.*
- *During playback in HD mode, the images may not appear on the player's LCD monitor if the component video cable is connected.*
- *When a cable is connected to the S2, AUDIO (L/R), VIDEO or headphone connector, sound cannot be heard from the speaker.*
- *According to the type of the connected TV and the recording mode, the playback picture may be squeezed vertically or horizontally. For details, refer to the Instructions of the TV.*

## Normal Playback Of Images

You can view the stored images in the memory card, one at a time, much like flipping through a photo album.

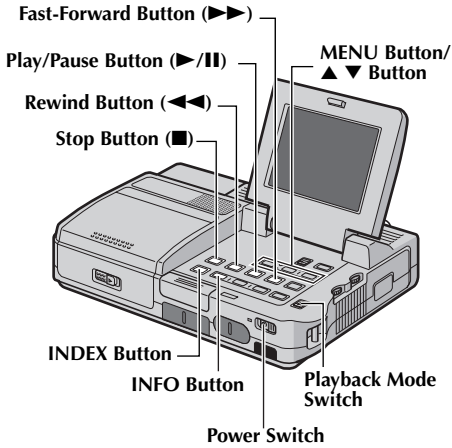

- 1 Open the LCD monitor fully.
  - Set the Video Output Mode Switch to "LCD MONITOR". (☞ pg. 13)
- 2 Load a memory card. (☞ pg. 17)
- 3 Set the Playback Mode Switch to "MEMORY".
- 4 Set the Power Switch to "ON" while pressing down the Lock Button located on the switch.
  - The still image which has been played back at the last time is displayed.
- 5 Press ◀◀ to display the previous file. Press ▶▶ to display the next file.
  - Pressing INFO gives you details on the displayed file. (☞ pg. 23)
  - You can also look for the desired file using Index Screen. (☞ pg. 23)
  - You can turn off the on-screen playback display. (☞ pg. 23)

### NOTES:

- Images shot in a file size other than "640 x 480", "848 x 480", "1280 x 720" and "1280 x 960" with another devices will be displayed thumbnail images. These thumbnail images cannot be transferred to a PC.
- Images shot with devices (such as JVC GR-DVM70) that are not compatible with DCF cannot be viewed with this player; "UNSUPPORTED FILE!" will be displayed.

### Playback Zoom

Available only with the remote control (provided). (☞ pg. 41)

## Auto Playback Of Images

You can run through all the images stored in memory card automatically.

- 1 Perform steps 1 – 4 in "Normal Playback Of Images".
- 2 Press ▶/II to start Auto Playback. Files are displayed in descending order.
  - If you press ◀◀ during Auto Playback, files are displayed in ascending order.
- 3 To end Auto Playback, press ■.

[For Normal Playback]

[For Auto Playback]

To display the next image

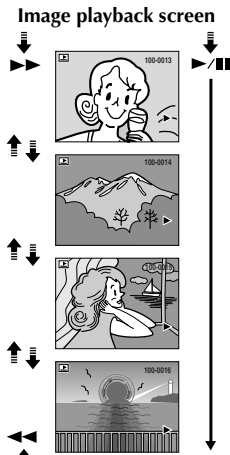

To display the previous image

## Index Playback Of Files

You can view several different files stored in the memory card at a time. This browsing capability makes it easy to locate a particular file you want.

- 1 Perform steps 1 – 4 in “Normal Playback Of Images” (☞ pg. 22).
- 2 Press **INDEX**. The Index Screen of the image files appears.

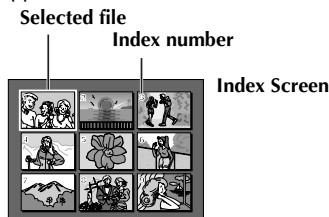

- 3 Press **▲** or **▼** to move the frame to the desired file.
  - Press **◀◀** to display the previous page. Press **▶▶** to display the next page.
- 4 Press **MENU**. The selected file is displayed.
  - Pressing **INFO** gives you details on the displayed file. (See below.)

## Viewing File Information

You can get the relevant file information by pressing the **INFO** Button during normal playback or Index Playback.

- FOLDER : Folder name (☞ pg. 26)  
 FILE : File name (☞ pg. 26)  
 DATE : Date the file was made  
 SIZE : Image size  
 QUALITY : Picture quality  
 PROTECT : When set to “ON”, the file is protected from accidental erasure. (☞ pg. 24)

```
FOLDER : 100JVCGR
FILE : DVC00010
DATE : OCT 03 03
SIZE : 1280X720
QUALITY : FINE
PROTECT : OFF
```

### Information Screen

- Press the **INFO** Button again to close the Information Screen.

#### NOTE:

With images shot with other devices or processed on a PC, “QUALITY: ---” will be displayed.

## Removing On-Screen Display

- 1 Perform steps 1 – 4 in “Normal Playback Of Images” (☞ pg. 22).
- 2 Press **MENU**. The Menu Screen appears.
- 3 Press **▲** or **▼** to select “DISPLAY”, and press **MENU**. The Sub Menu appears.
- 4 Press **▲** or **▼** to select “OFF”, and press **MENU**. The operation mode indicator, folder/file number and battery indicator (☞ ) disappear.
  - To display the indicators again, select “ON”.

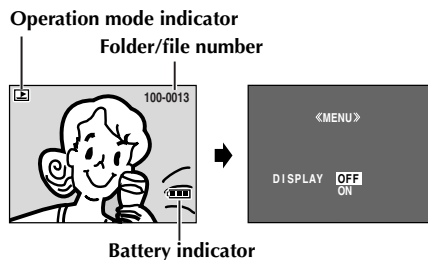

## Protecting Files

The Protect mode helps prevent the accidental erasure of files.

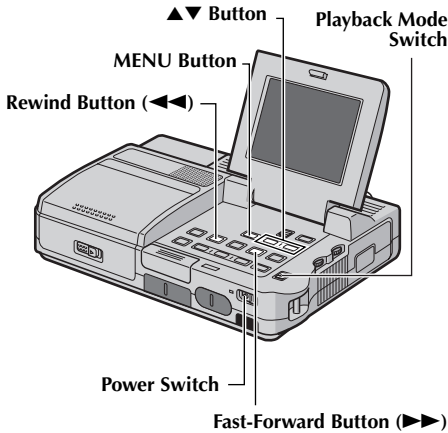

- 1** Open the LCD monitor fully.
  - Set the Video Output Mode Switch to "LCD MONITOR". (☞ pg. 13)
- 2** Load a memory card. (☞ pg. 17)
- 3** Set the Playback Mode Switch to "MEMORY".
- 4** Set the Power Switch to "ON" while pressing down the Lock Button located on the switch.
  - The still image which has been played back at the last time is displayed.
- 5** Press MENU. The Menu Screen appears.
- 6** Press ▲ or ▼ to select "PROTECT", and press MENU. The Sub Menu appears.



### To protect the currently displayed file

- 7** Press ▲ or ▼ to select "CURRENT", and press MENU. The PROTECT screen appears.
- 8** Press ◀◀ or ▶▶ to select the desired file.
- 9** Press ▲ or ▼ to select "EXECUTE", and press MENU.
  - To cancel protection, select "RETURN".
  - Repeat steps 8 and 9 for all files you want to protect.



### To protect all files stored in the memory card

- 7** Press ▲ or ▼ to select "PROT.ALL", and press MENU. The PROTECT screen appears.
- 8** Press ▲ or ▼ to select "EXECUTE", and press MENU.
  - To cancel protection, select "RETURN".

#### NOTES:

- If the "Ⓞ" mark appears, the currently displayed file is protected.
- When the memory card is initialized or corrupted, even protected files are deleted. If you do not want to lose important files, transfer them to a PC and save them.

### To Remove Protection

Before doing the following, perform steps 1 – 6 in "Protecting Files" in the left column.

#### To remove protection from the currently displayed file

- 7** Press ▲ or ▼ to select "CURRENT", and press MENU. The PROTECT screen appears.
- 8** Press ◀◀ or ▶▶ to select the desired file.
- 9** Press ▲ or ▼ to select "EXECUTE", and press MENU.
  - To cancel selection, select "RETURN".
  - Repeat steps 8 and 9 for all files you want to remove protection.



## To remove protection from all files stored in the memory card

- 7** Press ▲ or ▼ to select "CANC.ALL", and press **MENU**. The PROTECT screen appears.
- 8** Press ▲ or ▼ to select "EXECUTE", and press **MENU**.
  - To cancel selection, select "RETURN".

## Deleting Files

Previously stored files can be deleted either one at a time or all at once.

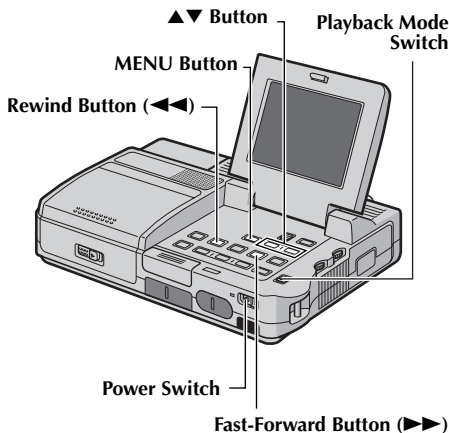

- 1** Open the LCD monitor fully.
  - Set the Video Output Mode Switch to "LCD MONITOR". (☞ pg. 13)
- 2** Load a memory card. (☞ pg. 17)
- 3** Set the Playback Mode Switch to "MEMORY".
- 4** Set the Power Switch to "ON" while pressing down the Lock Button located on the switch.
  - The still image which has been played back at the last time is displayed.
- 5** Press **MENU**. The Menu Screen appears.
- 6** Press ▲ or ▼ to select "DELETE", and press **MENU**. The Sub Menu appears.

## To delete the currently displayed file

- 7** Press ▲ or ▼ to select "CURRENT", and press **MENU**. The DELETE screen appears.
- 8** Press ◀◀ or ▶▶ to select the desired file.
- 9** Press ▲ or ▼ to select "EXECUTE", and press **MENU**.
  - To cancel deletion, select "RETURN".
  - Repeat steps **8** and **9** for all files you want to delete.

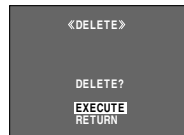
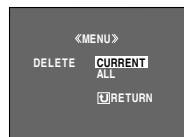

### NOTE:

If the "Ⓜ" mark appears, the selected file is protected and cannot be deleted.

## To delete all files stored in the memory card

- 7** Press ▲ or ▼ to select "ALL", and press **MENU**. The DELETE screen appears.
- 8** Press ▲ or ▼ to select "EXECUTE", and press **MENU**.
  - To cancel deletion, select "RETURN".

### NOTES:

- Protected files (☞ pg. 24) cannot be deleted. To delete them, remove protection first.
- Once files are deleted, they cannot be restored. Check files before deleting.

### CAUTION:

Do not remove the memory card or perform any other operation (such as turning off the player) during deletion. Also, be sure to use the provided AC Power Adapter/Charger, as the memory card may be corrupted if the battery becomes exhausted during deletion. If the memory card becomes corrupted, initialize it. (☞ pg. 27)

## Resetting The File Name

By resetting the file name, a new folder will be made. The new files you are going to make will be stored in the new folder. It is convenient to separate the new files from previously made files.

- 1 Open the LCD monitor fully.
  - Set the Video Output Mode Switch to "LCD MONITOR". (☞ pg. 13)
- 2 Load a memory card. (☞ pg. 17)
- 3 Set the Playback Mode Switch to "MEMORY".
- 4 Set the Power Switch to "ON" while pressing down the Lock Button located on the switch.
  - The still image which has been played back at the last time is displayed.
- 5 Press **MENU**. The Menu Screen appears.
- 6 Press **▲** or **▼** to select "NO. RESET", and press **MENU**. The NO. RESET screen appears.
- 7 Press **▲** or **▼** to select "EXECUTE", and press **MENU**. The new folder (such as "101JVCGR") will be made and the file made of the next shot starts from DVC00001.

### Folder and File names

Each time you dub still images recorded on a tape to a memory card, a file name is made using a number which is larger by one than the largest number of the file names which are in use. Even if you delete an image file with a number in the middle of range, the number will not be used for a new shot; a gap will remain in the numerical sequence. If the file name reaches DVC09999, a new folder (such as "101JVCGR") will be made and the file name will start again from DVC00001.

## Setting Print Information (DPOF Setting)

This player is compatible with the DPOF (Digital Print Order Format) standard in order to support future systems such as automatic printing. You can select one of the 2 print information settings for images stored in the memory card: "To Print All Still Images (One Print For Each)" or "To Print By Selecting Still Images And Number Of Prints".

### NOTES:

- If you load a memory card already set as shown below in a printer compatible with DPOF, it will make prints of the selected still images automatically.
- To print images recorded on a tape, first dub them to a memory card. (☞ pg. 38)

### To Print All Still Images (One Print For Each)

- 1 Open the LCD monitor fully.
  - Set the Video Output Mode Switch to "LCD MONITOR". (☞ pg. 13)
- 2 Load a memory card. (☞ pg. 17)
- 3 Set the Playback Mode Switch to "MEMORY".
- 4 Set the Power Switch to "ON" while pressing down the Lock Button located on the switch.
  - The still image which has been played back at the last time is displayed.
- 5 Press **MENU**. The Menu Screen appears.
- 6 Press **▲** or **▼** to select "DPOF", and press **MENU**. The Sub Menu appears.
- 7 Press **▲** or **▼** to select "ALL 1", and press **MENU**. The DPOF screen appears.
- 8 Press **▲** or **▼** to select "EXECUTE", and press **MENU**. The normal playback screen appears.
  - To cancel selection, select "RETURN".



## To Print By Selecting Still Images And Number Of Prints

- 1 Perform steps 1 – 6 in “To Print All Still Images (One Print For Each)” (pg. 26).
- 2 Press ▲ or ▼ to select “CURRENT”, and press **MENU**. The DPOF screen appears.
- 3 Press ◀◀ or ▶▶ to select the desired file.
- 4 Press ▲ or ▼ to select the number indication (00), and press **MENU**.
- 5 Select the number of prints by pressing ▲ to increase number, or “▼” to decrease the number, and press **MENU**.
  - Repeat steps 3 through 5 for the desired number of prints.
  - The number of prints can be set up to 15.
  - To correct the number of prints, select the image again and change the number.
- 6 Press ▲ or ▼ to select “RETURN”, and press **MENU**. The “SAVE?” appears.
  - If you did not change any settings in step 3 through 5, the Menu Screen reappears.
- 7 Press ▲ or ▼ to select “EXECUTE” to save the setting you have just made, and press **MENU**.
  - To cancel selection, select “CANCEL”.

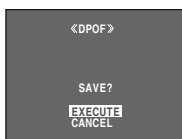
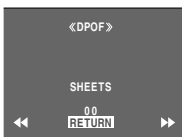

## To Reset The Number Of Prints

- 1 Perform steps 1 – 6 in “To Print All Still Images (One Print For Each)” (pg. 26).
- 2 Press ▲ or ▼ to select “RESET”, and press **MENU**. The DPOF screen appears.
- 3 Press ▲ or ▼ to select “EXECUTE”, and press **MENU**. The normal playback screen appears.
  - To cancel selection, select “RETURN”.
  - The number of prints is reset to 0 for all still images.

### CAUTION:

While performing the above, never disconnect power, as this may cause the memory card to be corrupted.

## Initializing A Memory Card

You can initialize a memory card any time. After initializing, all files and data stored in the memory card, including those which have been protected, are cleared.

- 1 Open the LCD monitor fully.
  - Set the Video Output Mode Switch to “LCD MONITOR”. (pg. 13)
- 2 Set the Playback Mode Switch to “MEMORY”.
- 3 Set the Power Switch to “ON” while pressing down the Lock Button located on the switch.
- 4 Press **MENU**. The Menu Screen appears.
- 5 Press ▲ or ▼ to select “FORMAT”, and press **MENU**. The FORMAT screen appears.
- 6 Press ▲ or ▼ to select “EXECUTE”, and press **MENU**. The memory card is initialized.
  - When initialization is finished, “NO IMAGES STORED” appears.
  - To cancel initialization, select “RETURN”.



### CAUTION:

Do not perform any other operation (such as turning off the player) during initialization. Also, be sure to use the provided AC Power Adapter/Charger, as the memory card may be corrupted if the battery becomes exhausted during initialization.

## Changing The Menu Settings

This player is equipped with an easy-to-use, on-screen menu system that simplifies many of the more detailed player settings. (☞ pg. 29 – 31)

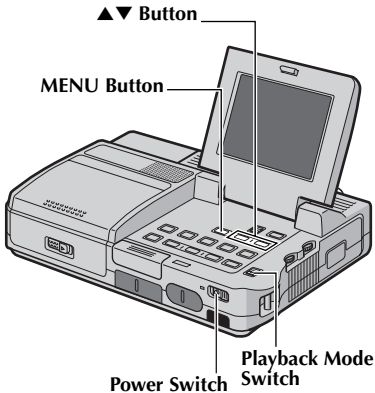

- 1 Open the LCD monitor fully.
  - Set the Video Output Mode Switch to "LCD MONITOR". (☞ pg. 13)
- 2 **For Video Playback Menus:**
  - 1) Set the Playback Mode Switch to "VIDEO".
  - 2) Set the Power Switch to "ON" while pressing down the Lock Button located on the switch.

### For D.S.C. Playback Menus:

For details, refer to "D.S.C. PLAYBACK" (☞ pg. 22).

- 3 Press **MENU**. The Menu Screen appears.
- 4 Press **▲** or **▼** to select the desired function, and press **MENU**. The selected function menu appears.
- 5 Press **▲** or **▼** to select the desired function, and press **MENU**. The Sub Menu appears.

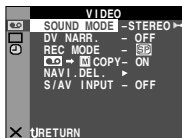

Example: **VIDEO** Menu

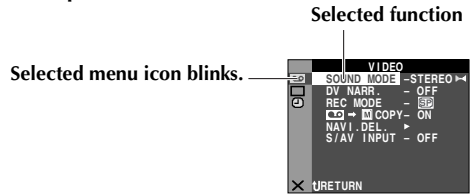

- 6 Press **▲** or **▼** to select the desired parameter.

Sub Menu

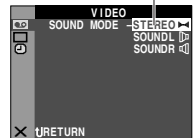

- 7 Press **MENU**. Selection is complete.
  - Repeat the procedure if you wish to set other function menus.
- 8 Press **MENU**. The Menu Screen returns.
  - Repeat the procedure if you wish to set other function menus.
- 9 Press **MENU** again. The Menu Screen closes.

### NOTES:

- The "DISPLAY" settings are effective only for video playback.
- The date indication can also be turned on/off by pressing the **DISPLAY** Button on the remote control (provided). (☞ pg. 21, 34)

## Video Menu

### VIDEO

#### Playback sound

During tape playback, the player detects the sound mode in which the recording was made, and plays the sound back. Select the type of sound to accompany your playback picture. According to the menu access explanation on page 28, select "SOUND MODE" or "DV NARR." from the Menu Screen and set it to the desired parameter.

**SOUND MODE** (Factory-preset: **STEREO**)

**STEREO**: Sound is output from both "L" and "R" channels in stereo.

**SOUND L**: Sound from the "L" channel is output.

**SOUND R**: Sound from the "R" channel is output.

**DV NARR.** (Factory-preset: **OFF**)

**OFF**: Original sound is output from both "L" and "R" channels in stereo.

**ON**: Dubbed sound is output from both "L" and "R" channels in stereo.

**MIX**: Original and dubbed sounds are combined and output in stereo on both "L" and "R" channels.

#### NOTES:

- The "SOUND MODE" setting is available for both 12-bit and 16-bit sound. (In previous models' functions, "12-bit" is called "32 kHz" and "16-bit" is called "48 kHz".)
- The player cannot detect the sound mode in which the recording was made during fast-forward or rewind. During playback the sound mode is displayed in the upper left corner.

#### Recording mode

Allows you to set the video recording mode (SP or LP) depending on your preference. It is recommended you use "REC MODE" in VIDEO Menu when using this player as a recorder during dubbing. (☞ pg. 34, 36)

**REC MODE** (Factory-preset: **SP**)  
**SP / LP**

#### Dubbing from tape to memory card

**COPY** (Factory-preset: **ON**)

**OFF**: When the **SNAP SHOT** button is pressed during tape playback, the playback image pauses and normal playback will resume after approximately 6 seconds. (The still image is not recorded.)

**ON**: Enables dubbing of images recorded on a tape to a memory card. (☞ pg. 38)

#### Deleting thumbnail images

For details, refer to "To delete thumbnail images" (☞ pg. 33).

**NAVI.DEL.**  
**IMAGE SEL. / TAPE SEL. / ALL / RETURN**

#### S-Video/AV input

**S/AV INPUT** (Factory-preset: **OFF**)

**OFF**: Enables audio and video signal output to a TV, VCR, etc. via the AUDIO (L/R) and VIDEO or AUDIO (L/R) and S2 connectors. (☞ pg. 20, 36)

**ON**: Enables audio and video signal input from the AUDIO (L/R) and VIDEO connectors, or audio and S-video signal input from the AUDIO (L/R) and S2 connectors. (☞ pg. 34)

#### NOTE:

When VIDEO and S2 connectors are simultaneously connected, S-video signal is input from the S2 connector.

## System Menu

### SYSTEM

#### Beep and melody sound

**BEEP** (Factory-preset: **OFF**)

**OFF:** The beep does not sound even when the operation is performed.

**BEEP:** The beep sounds when the operation is performed.

**MELODY:** Instead of a beep, a melody sounds when any operation is performed.

#### Remote control setting

For details, refer to "USING THE REMOTE CONTROL UNIT" (☞ pg. 39).

**REMOTE** (Factory-preset: **ON**)

**OFF:** Disables the remote control operations.

**ON:** Enables the remote control operations.

#### Component video output setting

When connecting the player to a TV or video unit equipped with component video inputs (☞ pg. 20), select the output picture size depending on the connected TV or video unit.

**Y/Pb/Pr** (Factory-preset: **NO CONV.**)

**NO CONV.:** Outputs with the original size. Signals are output in 480p during recording.

**720 to 1080:** Converts to 1080i. Signals are output in 480p during recording.

**ALL to 480p:** Converts to 480p.

**ALL to 480i:** Converts to 480i.

**ALL to 1080:** Converts to 1080i. Select this setting if your TV is compatible to 1080i input only.

Signals are not output during recording (in any mode) or playback in DV mode.

#### NOTE:

Signals are output in 480i during recording or playback in DV mode regardless of the output setting.

#### S-Video output setting

When connecting the player to a 4:3 TV or wide-screen TV using the S-video cable (☞ pg. 20), select the aspect ratio of the connected TV.

**S/VIDEO** (Factory-preset: **4:3 TV**)

**16:9 TV:** For a TV which has an aspect ratio of 16:9.

**4:3 TV:** For a TV which has an aspect ratio of 4:3.

#### i.LINK output setting

During digital tape dubbing, select whether the video signal outputs according to the Switch setting.

**i.LINK OUT** (Factory-preset: **SW**)

**SW:** Normally, set to this position. Outputs the DV or MPEG2 format signal selected with the i.LINK OUT Switch.

**AUTO:** For future use. If the connected video unit automatically detects the input signal via an i.LINK connector, set to "AUTO".

#### Picture quality

The Picture Quality mode can be selected to best match your needs. Two Picture Quality modes are available: FINE (☞) and STANDARD (☞) (in order of quality).

**QUALITY** (Factory-preset: **FINE**)

FINE / STANDARD

#### NOTE:

The number of storable images depends on the selected picture quality as well as the composition of the subjects in the images and the type of memory card being used.

#### Resetting menu settings

##### RESET

**EXECUTE:** Resets all settings to the factory-preset.

**RETURN:** Does not reset all settings to the factory-preset.

## Display Menu

### DISPLAY

#### Display setting

**ON SCREEN** (Factory-preset: **LCD**)

**OFF:** The player's display disappears.

**LCD:** Keeps the player's display (except the date, time and time code) from appearing on the connected TV screen.

**LCD/TV:** Makes the player's display appear on screen when the player is connected to a TV.

#### Date and time display setting

**DATE/TIME** (Factory-preset: **OFF**)

**OFF:** The date/time do not appear.

**AUTO:** The date/time are displayed in the following cases:

- When playback starts. The player displays the date/time when scenes are recorded.
- When the date is changed during playback.

**ON:** The date/time are always displayed.

#### Time code setting

**TIME CODE** (Factory-preset: **OFF**)

**OFF:** Time code is not displayed.

**ON:** Time code is displayed on the player and on the connected TV. Frame numbers are not displayed during recording.

#### Clock adjustment

**CLOCK ADJ.**

- Allows you to set the current date and time. (☞ pg. 15)

#### NOTE:

The date indication can also be turned on/off by pressing the **DISPLAY** Button on the remote control (provided). (☞ pg. 21, 34)

#### Display

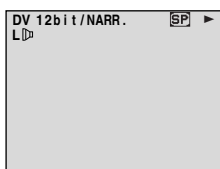

**ON SCREEN Setting:**  
For playback mode, playback sound, tape speed and tape running during video playback.

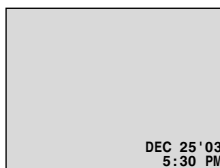

**DATE/TIME Setting:**  
For date/time.

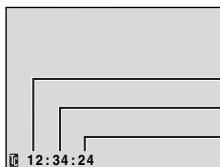

**TIME CODE Setting:**  
For time code.

Minutes  
Seconds  
Frames\*

\* 30 frames = 1 second

## NAVIGATION Function

The Navigation Function helps you check tape contents by making thumbnail images on a memory card.

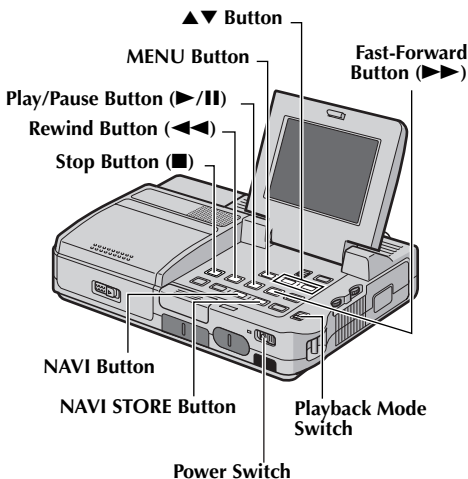

## To add thumbnail images during video playback

- 1** Perform steps **1** to **4** in “To find scenes on tape using thumbnail images (NAVIGATION Search)”.
- 2** Press ▶/|| to start video playback.
- 3** Press **NAVI STORE** at the desired point.
  - The “” indicator appears briefly and the image of the point where **NAVI STORE** is pressed is stored in the memory card as a thumbnail image.
  - If you use the tape recorded in SD or HD mode, it will enter the playback pause mode. To play, press ▶/||.

## To find scenes on tape using thumbnail images (NAVIGATION Search)

- 1** Load a cassette. (☞ pg. 16)
- 2** Load a memory card. (☞ pg. 17)
- 3** Set the Playback Mode switch to “VIDEO”.
- 4** Set the Power Switch to “ON” while pressing down the Lock Button located on the switch.
- 5** Press **NAVI** during video playback or stop mode.
  - The loaded cassette’s NAVIGATION thumbnail image screen appears.
  - Press ◀◀ to display the previous page. Press ▶▶ to display the next page.
- 6** Press ▲ or ▼ to select the desired image, and press **MENU**.
  - The “NAVIGATION SEARCH” indication appears blinking and the player starts searching the tape for the relevant point of the selected thumbnail image.



To cancel NAVIGATION search midway...

Press ■ or ▶/||.



## To delete thumbnail images

- 1 Load a memory card. (☞ pg. 17)
- 2 Set the Playback Mode switch to "VIDEO".
- 3 Set the Power Switch to "ON" while pressing down the Lock Button located on the switch.
- 4 Press **MENU**. The Menu Screen appears.
- 5 Press **▲** or **▼** to select "VIDEO", and press **MENU**. The VIDEO Menu appears.

- 6 Press **▲** or **▼** to select "NAVI.DEL.", and press **MENU**. The Sub Menu appears.

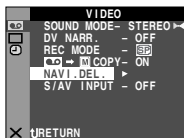

- 7 By pressing **▲** or **▼**...

Select "IMAGE SEL." to delete the currently displayed thumbnail image.

Select "TAPE SEL." to delete all thumbnail images for the tape which contains the currently displayed image.

Select "ALL" to delete all thumbnail images stored in the memory card at once.

- 8 Press **MENU**. The NAVIGATION screen appears.



- 9 Press **▲** or **▼** to select "EXECUTE", and press **MENU**.

- Press **◀** to display the previous page. Press **▶** to display the next page.
- To cancel deletion, select "RETURN".
- Thumbnail images cannot be deleted during video playback.

### CAUTION:

Do not remove the memory card or perform any other operation (such as turning off the player) during deletion. Also, be sure to use the provided AC Power Adapter/Charger, as the memory card may be corrupted if the battery becomes exhausted during deletion. If the memory card becomes corrupted, initialize it.

### NOTE:

Once images are deleted, they cannot be restored. Check images before deleting.

### IMPORTANT:

- Be sure to always use the same tape and memory card together as they were during recording; otherwise, the player cannot recognize Tape and Memory Card IDs to perform NAVIGATION function properly.
- Check if an appropriate tape and memory card are loaded when the following messages appear: "UNABLE TO USE NAVIGATION", "THIS MEMORY CARD IS NOT COMPATIBLE".
- NAVIGATION Search does not work if the current position is at a blank portion on the tape. Also, do not leave a blank portion partway through the tape when recording; otherwise, NAVIGATION function does not work properly.
- Before recording newly over a recorded tape, be sure to delete all thumbnail images of the previous recording from the relevant memory card.
- If you copy thumbnail images from one memory card to another via a PC, NAVIGATION Search does not work with the copied memory card.

## Dubbing To Or From A VCR

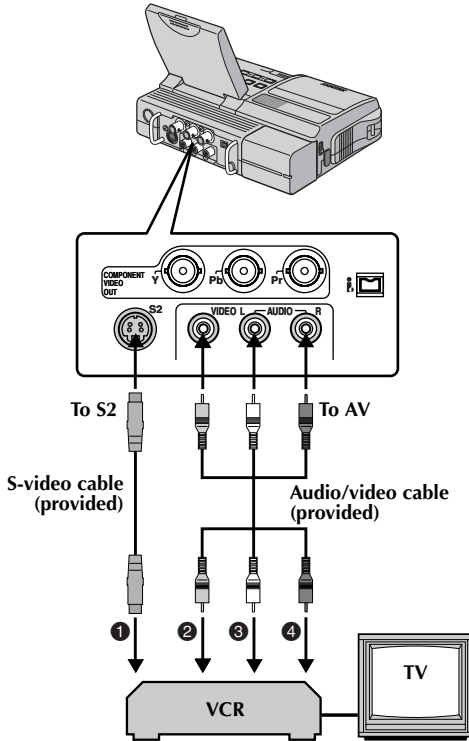

- ① To S-VIDEO\* IN or OUT
- ② Yellow to VIDEO IN or OUT
- ③ White to AUDIO L IN or OUT
- ④ Red to AUDIO R IN or OUT

\* Connect when your TV/VCR has an S-VIDEO IN/OUT connector. In this case, it is not necessary to connect the yellow video cable.

### To use this player as a player

- 1 Following the illustrations, connect the player and the VCR. Also refer to page 20.
- 2 Set the player's Playback Mode Switch to "VIDEO".
- 3 Set the Power Switch to "ON" while pressing down the Lock Button located on the switch.
- 4 Turn on the VCR's power.
- 5 Insert the source cassette in the player.
- 6 Insert the recording cassette in the VCR.
- 7 Engage the VCR's AUX and Record-Pause modes.
  - Refer to the instruction manual for the VCR.

- 8 Press ►/|| on the player to start playback of the source tape.
- 9 At the point you want to start dubbing, engage the VCR's Record mode.
- 10 To pause dubbing, engage the VCR's Record-Pause mode and press ►/|| on the player.
- 11 Repeat steps 8 – 10 for additional editing. Stop the VCR and player.

### NOTES:

- **It is recommended to use the AC Power Adapter/Charger as the power supply instead of the battery pack.** (☞ pg. 12)
- As the player starts to play your footage, it will appear on your TV. This will confirm the connections and the AUX channel for dubbing purposes.
- Before you start dubbing, make sure that the indications do not appear on the connected TV. If they do, they are being recorded onto the new tape.  
**To choose whether or not the following displays appear on the connected TV...**
  - **Date/time**  
Set "DATE/TIME" to "AUTO", "ON" or "OFF". (☞ pg. 28, 31) Or, press **DISPLAY** on the remote control to turn on/off the date indication.
  - **Time code**  
Set "TIME CODE" to "OFF" or "ON". (☞ pg. 28, 31)
  - **Indications other than date/time and time code**  
Set "ON SCREEN" to "OFF", "LCD" or "LCD/TV". (☞ pg. 28, 31)
- Playback images recorded in HD or SD mode with this player will be converted to DV format (480i) image.

### To use this player as a recorder

- 1) Perform steps 1 to 3 in the left column.
- 2) Set "S/AV INPUT" to "ON". (☞ pg. 28, 29)
- 3) Set "REC MODE" to "SP" or "LP". (☞ pg. 28, 29)
- 4) Insert the recording cassette in this player.
- 5) Press and hold **REC** (●), then press ►/|| to engage the Record-Pause mode. The "AV in" indication appears on the screen.
- 6) Press ►/|| to start recording. The ⏻ indication rotates.
- 7) Press ■ to stop recording. The ⏻ indication stops rotating.

**NOTES:**

- After dubbing, set "S/AV INPUT" back to "OFF".
- Analog signals can be converted to digital signals with this procedure.
- It is also possible to dub from another player.
- Depending on the tape source input, images may appear with horizontal jitter on the player's LCD monitor during dubbing. This does not affect the actual recording.

## Dubbing To Or From A Video Unit Equipped With An i.LINK Connector (Digital Dubbing)

Using an i.LINK cable (optional), it is possible to dub recorded scenes in DV format from the player onto another video unit equipped with i.LINK connector. Since a digital signal is sent, there is little if any image or sound deterioration. Images recorded in SD or HD mode can be dubbed only to a D-VHS VCR with HS mode or digital HD video camera (ex. GR-HD1 or JY-HD10).

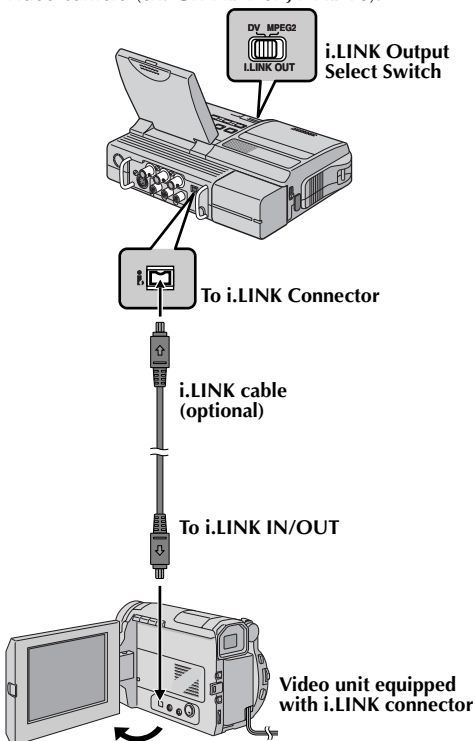
**NOTES:**

- **It is recommended to use the AC Power Adapter/Charger as the power supply instead of the battery pack.** (☞ pg. 12)
- **When using an i.LINK cable, be sure to use the optional JVC VC-VDV204U i.LINK cable.**
- If the remote control is used when both the player and recorder are JVC video units, both units will perform the same operation. To prevent this from happening, press the buttons on both units.
- It is possible to dub in MPEG2 format from a D-VHS VCR, if the source tape (D-VHS) has been originally dubbed from this digital HD player or digital HD video camera (ex. GR-HD1 or JY-HD10) in MPEG2 format.

### To use this player as a player

- 1 Make sure all units are turned off.
- 2 Connect this player to a video unit equipped with an i.LINK input connector using an i.LINK cable as shown in the illustration.
- 3 Set this player's Playback Mode Switch to "VIDEO".
- 4 Set "i.LINK OUT" to "SW". (☞ pg. 28, 30)
  - If, in future, the connected video unit automatically detects the DV and MPEG2 formats, set "i.LINK OUT" to "AUTO". In this case, proceed to step 6.
- 5 Set the i.LINK Output Select Switch on this player to "DV" to output scenes recorded in DV mode, or "MPEG2" to output scenes recorded in HD or SD mode.
- 6 Turn on the video unit's power.
- 7 Insert the source cassette in this player.
- 8 Insert the recording cassette in the video unit.
- 9 Press ►/II on this player to start playback of the source cassette.
- 10 At the point you want to start dubbing, engage the video unit's Record mode.
- 11 To pause dubbing, engage the video unit's Record-Pause mode and press ►/II on this player.
- 12 Repeat steps 10 – 11 for additional editing. Stop the video unit and player.

**NOTES:**

- If a blank portion or disturbed image is played back on the player during dubbing, unusual images may be dubbed or the dubbing may stop.
- If a scene which has been paused during recording is dubbed to other devices, playback may stop at the point.
- Do not connect the player through a hub.

## To use this player as a recorder

Dubbing from other devices in MPEG2 format is possible if the connected device is another same model of this unit. It is also possible to dub in MPEG2 format from a D-VHS VCR, if the source tape (D-VHS) has been originally dubbed from this digital HD player in MPEG2 format.

- However, if signals on the D-VHS tape are originally from an ATSC tuner etc., dubbing from a D-VHS VCR in MPEG2 format is not possible.

- 1 Perform step 1 to 4 of "To use this player as a player" (☞ pg. 35).
- 2 Set "REC MODE" to "SP" or "LP". (☞ pg. 28, 29)
- 3 Turn on the video unit's power.
- 4 Insert the source cassette in the video unit.
- 5 Insert the recording cassette in this player.
- 6 Press and hold REC (●), then press ►/II to engage the Record Pause mode.
  - The "i.LINK in" indication appears on the screen.
- 7 Press ►/II again to start recording.
  - The ⏻ indication rotates.
- 8 Press ►/II again to engage the Record-Pause mode.
  - The ⏻ indication stops rotating.
- 9 Repeat steps 7 – 8 for additional editing. Stop the video unit and player.

### NOTES:

#### DV to DV dubbing

- If a blank portion or disturbed image is played back on the player during dubbing, unusual images may be dubbed or the dubbing may stop.

#### MPEG2 to MPEG2 dubbing

- **It is not possible to dub signals in MPEG2 format from devices other than D-VHS VCRs or another same model of this player.**
- MPEG2 signals that are copy-guarded may not be recorded with this player.
- When dubbing MPEG2 video to the player, image may not appear on the LCD monitor. However, the recording is performed properly.

### Notes on dubbing to a D-VHS VCR

Dubbing cannot be conducted properly when dubbing a tape which is recorded in both DV and HD (or SD) mode. In this case, perform the following procedure.

- 1) Disconnect the i.LINK cable.
- 2) Reset the i.LINK device number on the D-VHS VCR.
  - For the operation, refer to the instruction manual of the D-VHS VCR.
- 3) Set "i.LINK OUT" to "SW" on this player. (☞ pg. 28, 30)

- 4) Set the i.LINK Output Select Switch on this player to "DV" to output scenes recorded in DV mode, or "MPEG2" to output scenes recorded in HD or SD mode.
- 5) Connect the i.LINK cable again.
- 6) Start playback on this player, and then start recording on the D-VHS VCR.

## Recording From The Middle Of A Tape

- 1) Play back a tape or use Blank Search (☞ pg. 19) to find the spot at which you want to start recording, then engage the Still Playback mode. (☞ pg. 18)

### NOTES:

- The time code cannot be reset.
- During fast-forwarding and rewinding, the time code indication does not move smoothly.
- The time code is displayed only when "TIME CODE" is set to "ON". (☞ pg. 31)

### When a blank portion is recorded on a tape

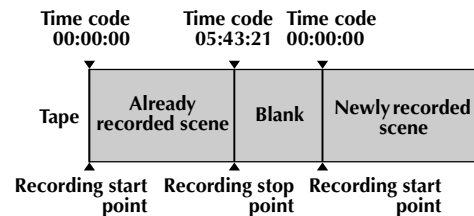

### Proper recording

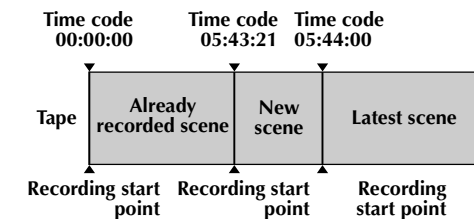

## Recording Mode

### DV (480i):

The player records signals in the interlace scan mode (half of 525 scanning lines at 1/60th of a second).

The image will be recorded in an aspect ratio of 4:3.

The DV mode is suitable for playback on a conventional 4:3-screen TV.

### SD (480p):

The player records signals in the progressive scan mode (525 scanning lines at 1/60th a second at one time).

The SD mode reduces flickering more effectively than a recording in DV mode.

The image will be recorded in an aspect ratio of 16:9. The SD mode is suitable for playback on a wide-screen TV or high definition TV.

### HD (720p):

The player records signals in the progressive scan mode (750 scanning lines at 1/30th of a second for recording and 1/60th of a second for playback at one time).

The HD mode enables digital high definition recording that offers higher picture quality than a recording in SD or DV mode.

The image will be recorded in an aspect ratio of 16:9. The HD mode is suitable for playback on a wide-screen TV or high definition TV.

## Supported formats

Horizontal lines	Vertical lines	Aspect ratio	Frames per sec. (PB.)	Scan mode	Recording mode
1280	720	16:9	30	Progressive	HD
720	480	16:9	60	Progressive	SD
720	480	4:3	60	Interlaced	DV

## Recording modes and features

There are some features which are not available depending on the recording mode.

Yes: Available

No: Not Available

Features	DV	SD	HD
Frame-By-Frame Playback (Ⓞ pg. 18)	Yes	No	No
Slow-Motion Playback (Ⓞ pg. 40)	Yes	No	No
Playback Zoom (Ⓞ pg. 41)	Yes	No	No
Audio Dubbing (Ⓞ pg. 42)	Yes	No	No

## Dubbing Still Images Recorded On A Tape To A Memory Card

Still images can be dubbed from a tape to a memory card.

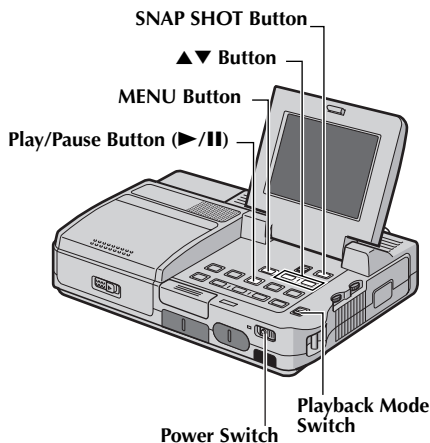

- 1 Load a cassette. (☞ pg. 16)
- 2 Load a memory card. (☞ pg. 17)
- 3 Set the Playback Mode Switch to "VIDEO".
- 4 Set the Power Switch to "ON" while pressing down the Lock Button located on the switch.
- 5 Set "COPY" to "ON". (☞ pg. 28, 29)
- 6 Press ▶/|| to start playback.
- 7 At the point you want to dub, press ▶/|| again to engage Still Playback.
- 8 To dub the image, press **SNAP SHOT**.
  - The "▶ [P]" indication appears during dubbing.
  - The selected image is stored in the memory card.

### NOTES:

- If **SNAP SHOT** is pressed in step 8 when a memory card is not loaded, the message "COPYING FAILED" is displayed.
- To use Playback Special effects with a video image you wish to dub, perform up to step 8 using the remote control (provided). (☞ pg. 41)
- Images are dubbed in the following image sizes:  
 Scenes recorded in HD mode: 1280 x 720 pixels  
 Scenes recorded in SD mode: 848 x 480 pixels  
 Scenes recorded in DV mode: 640 x 480 pixels

### Approximate Number of Storable Images

Image Size/Picture Quality	SD Memory Card			
	8 MB	16 MB	32 MB	64 MB
640 x 480/FINE	30	68	144	297
640 x 480/STANDARD	80	178	376	772
848 x 480/FINE	25	55	117	241
848 x 480/STANDARD	66	148	313	643
1280 x 720/FINE	10	22	48	99
1280 x 720/STANDARD	26	59	125	257

Image Size/Picture Quality	MultiMediaCard		
	8 MB	16 MB	32 MB
640 x 480/FINE	36	74	149
640 x 480/STANDARD	95	192	388
848 x 480/FINE	29	60	121
848 x 480/STANDARD	79	160	323
1280 x 720/FINE	12	24	49
1280 x 720/STANDARD	31	64	129

The Full-Function Remote Control Unit can operate this player from a distance. It also makes additional playback functions possible. (☞ pg. 40, 41)

**Installing The Battery**

The remote control uses one lithium battery (CR2025).

- 1** Pull out the battery holder by inserting a pointed instrument into the slot.
- 2** Insert the battery in the holder, and be sure to have the “+” mark visible.
- 3** Slide the holder back in until you hear a click.

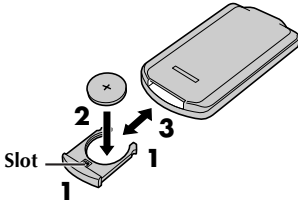

**Beam Effective Area (indoor use)**

When using the remote control, be sure to point it at the remote sensor. The transmitted beam's approximate effective distance for indoor use is 5 m (16 ft).

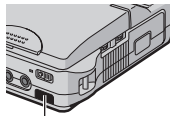

Remote sensor

**NOTE:**

*The transmitted beam may not be effective or may cause incorrect operation when the remote sensor is directly exposed to sunlight or powerful lighting.*

**Buttons And Functions**

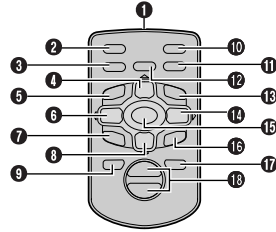

- 1** Infrared beam transmitting window
- 2** S.SHOT (Snapshot) Button\*
- 3** AUDIO Button ..... (☞ pg. 28, 29)
- 4** PAUSE Button\* ..... (☞ pg. 40)  
Up Button\* ..... (☞ pg. 41)
- 5** SLOW Rewind Button ..... (☞ pg. 40)
- 6** REW Button\* ..... (☞ pg. 19, 22)  
Left Button ..... (☞ pg. 41)
- 7** INSERT Button\*\*
- 8** STOP Button\* ..... (☞ pg. 18, 22)  
Down Button\* ..... (☞ pg. 41)
- 9** SHIFT Button ..... (☞ pg. 41)
- 10** START/STOP Button\*
- 11** EFFECT ON/OFF Button ..... (☞ pg. 41)
- 12** EFFECT Button ..... (☞ pg. 41)
- 13** SLOW Forward Button ..... (☞ pg. 40)
- 14** FF Button\* ..... (☞ pg. 19, 22)  
Right Button ..... (☞ pg. 41)
- 15** PLAY Button\* ..... (☞ pg. 18, 22)
- 16** A. DUB Button ..... (☞ pg. 42)
- 17** DISPLAY Button ..... (☞ pg. 21, 34)
- 18** Zoom (T/W) Buttons ..... (☞ pg. 41)

\* Functions the same as each corresponding button on the player. (☞ pg. 59)  
\*\* Unavailable with this player

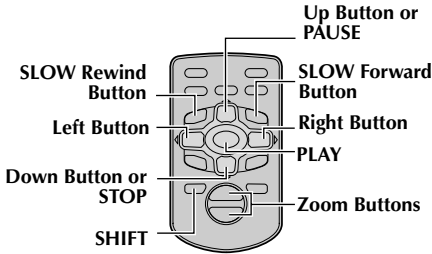

### Frame-By-Frame Playback (DV mode only)

Allows frame-by-frame search during video playback.

During normal or still playback, press **SLOW** (▶) repeatedly for forward or **SLOW** (◀) repeatedly for reverse. Each time **SLOW** (◀ or ▶) is pressed, the frame is played back.

### Slow-Motion Playback (DV mode only)

Allows slow-speed search in either direction during video playback.

During normal video playback, press **SLOW** (◀ or ▶) more than approx. 2 seconds.

- After approx. 5 minutes (approx. 20 seconds with an 80-minute cassette) in Slow Rewind or approx. 5 minutes in Slow Forward, normal playback resumes.
- To pause Slow-Motion playback, press **PAUSE** (⏏).
- To stop Slow-Motion playback, press **PLAY** (▶).



#### NOTES:

- You can also engage Slow-Motion Playback from Still Playback by pressing **SLOW** (◀ or ▶) more than approx. 2 seconds.
- During Slow-Motion Playback, due to digital image processing, the picture may take on a mosaic effect.
- After **SLOW** (◀ or ▶) is pressed and held, the still image may be displayed for a few seconds, followed by a blue screen for a few seconds. This is not a malfunction.
- There may be a small margin between the slow-motion playback start point you chose and the actual start point for Slow-Motion Playback.
- During Slow-Motion Playback, there will be disturbances in video and the picture may seem unstable, especially with steady images. This is not a malfunction.



## Playback Zoom (DV mode only)

Magnifies the recorded image up to 10X at any time during video playback and D.S.C. playback.

- 1) Press **PLAY** (▶) to start video playback. Or perform normal playback of images.
 
- 2) At the point you want to zoom in, press the Zoom Button (T).
  - To zoom out, press the Zoom Button (W).
- 3) You can move the image on the screen around to find a particular portion of the picture. While holding down **SHIFT**, press ◀ (Left), ▶ (Right), ▲ (Up) and ▼ (Down).
  - To end zoom, press and hold **W** until magnification returns to normal. Or, press **STOP** (■) and then press **PLAY** (▶) during video playback.

### NOTES:

- Zoom can also be used during slow-motion and still playback.
- Due to digital image processing, the quality of the image may suffer.

## Playback Special Effects (DV mode only)

Allows you to add creative effects to the video playback image that was recorded in DV mode. The effects that can be used during playback are CLASSIC FILM, MONOTONE, SEPIA and STROBE.

- **CLASSIC FILM:** Gives recorded scenes a strobe effect.

**B/W MONOTONE:** Like classic black and white films, your footage is shot in B/W.

▣ **SEPIA:** Recorded scenes have a brownish tint like old photos.

▣ **STROBE:** Your recording looks like a series of consecutive snapshots.

- 1) To start playback, press **PLAY** (▶).
- 2) Press **EFFECT**. The PLAYBACK EFFECT Select Menu appears.
- 3) Press **EFFECT** repeatedly to move the highlight bar to the desired effect.
  - The selected function is activated and after 2 seconds the menu disappears.
  - To deactivate the selected effect, press **EFFECT ON/OFF**. To reactivate the selected effect press **EFFECT ON/OFF** again.
  - To change the selected effect, repeat from step 2 above.

## Audio Dubbing (DV mode only)

The audio track of a tape recorded in DV format can be customized only when recorded in the 12-bit and SP modes. (☞ pg. 29)

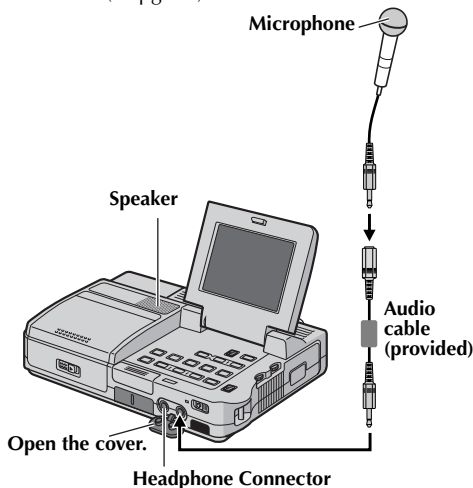

### NOTES:

- When editing onto a tape that was recorded at 12-bit, the old and new soundtracks are recorded separately.
- If you dub onto a blank space on the tape, the sound may be disrupted. Make sure you only edit recorded areas.
- If feedback or howling occurs during TV playback, move the microphone away from the TV, or turn down the TV's volume.
- If you change from 12-bit to 16-bit in mid-recording and then use the tape for Audio Dubbing, it is not effective from the point where 16-bit recording began.
- During Audio Dubbing, when the tape moves to scenes recorded in the LP mode, scenes recorded in 16-bit audio or a blank portion, Audio Dubbing stops.
- To perform Audio Dubbing while watching on the television, make connections. (☞ pg. 20)
- To perform Audio Dubbing with a video unit connected to the player's S2, AUDIO(L/R), VIDEO connector, first set "S/AV INPUT" to "ON" in VIDEO Menu. (☞ pg. 28, 29)  
The "AUX" indication appears instead of "MIC".

- 1 Play back the tape to locate the point where editing will start, then press **PAUSE (II)**.
- 2 While holding **A. DUB (⊖)** on the remote control, press **PAUSE (II)**. The "II⊖" and "MIC" indicators appear.
- 3 Press **PLAY (▶)**, then begin "narrating". Speak into the microphone.
  - To pause dubbing, press **PAUSE (II)**.
- 4 To end Audio Dubbing, press **PAUSE (II)**, then **STOP (■)**.

### To hear the sound during Audio Dubbing...

Connect optional headphones to the headphone connector or use the S2, AUDIO(L/R), VIDEO connector, and set "DV NARR." to the desired mode;

- "OFF" for the playback sound.
- "ON" for the dubbed sound.
- "MIX" for the playback and dubbed sound.

### To hear the dubbed sound during playback...

Set "DV NARR." to "ON" or "MIX". (☞ pg. 28, 29)

## Connection To A Personal Computer

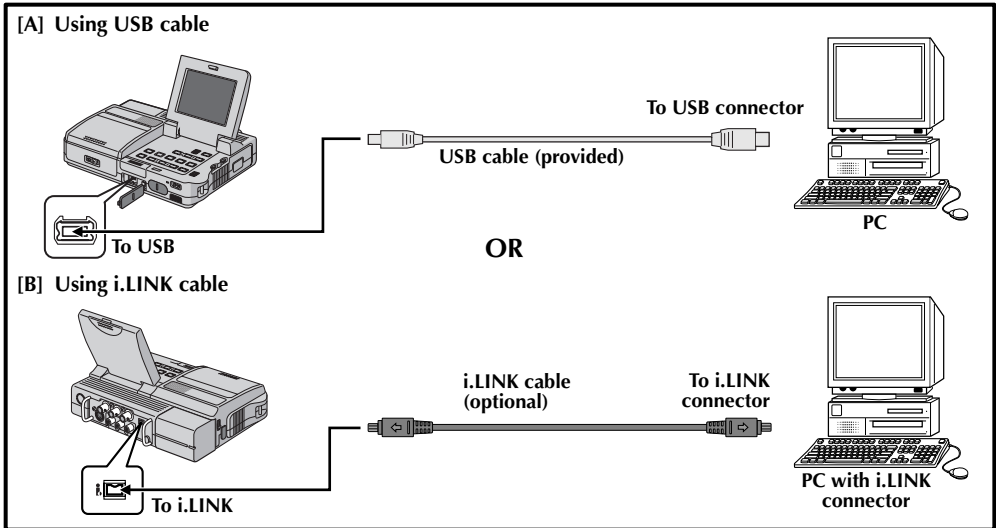

### [A] Using USB cable

It is possible to do the following things:

- Transfer still images stored on a memory card to a PC.

### [B] Using i.LINK cable

It is also possible to transfer still/moving images to a PC with an i.LINK connector by using the software equipped with the PC or commercially available software.

- Set "i.LINK OUT" to "SW". (☞ pg. 30)
- Set the i.Link Output Select Switch on this player to the appropriate mode (☞ pg. 35); "DV": when using the DV editing software "MPEG2": when using the MPEG2 editing software
- Set the i.Link Output Select Switch to the appropriate mode before connecting the i.Link cable.

#### NOTES:

- **It is recommended to use the AC Power Adapter/Charger as the power supply instead of the battery pack.** (☞ pg. 12)
- **Never connect the USB cable and the i.LINK cable simultaneously to the player. Connect only the cable you wish to use to the player.**
- **Do not connect the player through a hub.**

- **When using an i.LINK cable, be sure to use the optional JVC VC-VDV206U or VC-VDV204U i.LINK cable depending on the type of i.LINK connector (4 or 6 pins) on the PC.**
- **If the PC connected to the player via the USB cable is not powered, the player does not enter the USB mode.**
- **The date/time information cannot be captured into the PC.**
- **Refer to the instruction manuals of the PC and Software.**
- **The still images can also be transferred to a PC with an i.LINK connector-equipped capture board.**
- **The system may not work properly depending on the PC or capture board you are using.**

"USB MODE" and/or "ACCESSING FILES" appears on the LCD monitor while the PC is accessing data in the player or the player is transferring a file to the PC. **NEVER disconnect the USB cable while "ACCESSING FILES" is displayed on the LCD monitor since this can result in product damage.**

ITEMS	NOTES
⇨ Power (☞ pg. 11)	<ul style="list-style-type: none"> <li>● Perform charging where the temperature is between 10°C and 35°C (50°F and 95°F). 20°C to 25°C (68°F to 77°F) is the ideal temperature range for charging. If the environment is too cold, charging may be incomplete.</li> <li>● Charging times are for a fully discharged battery pack.</li> <li>● Charging time varies according to the ambient temperature and the status of the battery pack.</li> <li>● To avoid interference with reception, do not use the AC Power Adapter/Charger near a radio.</li> <li>● Since the AC Power Adapter/Charger processes electricity internally, it becomes warm during use. Be sure to use it only in well-ventilated areas.</li> </ul>
⇨ VIDEO PLAYBACK (☞ pg. 18)	<ul style="list-style-type: none"> <li>● When you use the LCD monitor outdoors in direct sunlight, the LCD monitor may be difficult to see.</li> <li>● The cassette holder cannot be opened unless a power supply is attached.</li> <li>● There may be a delay after you open the cassette holder cover until the cassette holder opens. Do not use force.</li> <li>● Once the cassette holder is closed, it recedes automatically. Wait until it recedes completely before closing the cassette holder cover.</li> <li>● "TAPE END" appears when the tape reaches its end, and the power goes off automatically if left in this condition for 5 minutes. "TAPE END" also appears when a cassette at its end is loaded.</li> </ul>

If, after following the steps in the chart below, the problem still exists, please consult your nearest JVC dealer.

The player is a microcomputer-controlled device. External noise and interference (from a TV, a radio, etc.) might prevent it from functioning properly. In such cases, first disconnect its power supply unit (battery pack, AC Power Adapter/Charger, etc.) and wait a few minutes; and then re-connect it and proceed as usual from the beginning.

## Power

SYMPTOM	POSSIBLE CAUSES	CORRECTIVE ACTION
1. No power is supplied.	1. <ul style="list-style-type: none"> <li>• The power is not connected properly.</li> <li>• The battery is dead.</li> </ul>	1. <ul style="list-style-type: none"> <li>• Connect the AC Power Adapter/Charger securely. (☞ pg. 12)</li> <li>• Replace the dead battery with a fully charged one. (☞ pg. 11, 12)</li> </ul>

## Video and D.S.C. Playback

SYMPTOM	POSSIBLE CAUSES	CORRECTIVE ACTION
2. Play, Rewind and Fast-Forward functions do not work.	2. <ul style="list-style-type: none"> <li>• The Playback Mode Switch is set to "MEMORY".</li> </ul>	2. <ul style="list-style-type: none"> <li>• Set the Playback Mode Switch to "VIDEO".</li> </ul>
3. The tape is moving, but there is no picture.	3. <ul style="list-style-type: none"> <li>• Your TV has AV input terminals, but is not set to its VIDEO mode.</li> <li>• The cassette holder cover is open.</li> </ul>	3. <ul style="list-style-type: none"> <li>• Set the TV to the mode or channel appropriate for video playback. (☞ pg. 20)</li> <li>• Close the cassette holder cover. (☞ pg. 16)</li> </ul>
4. Blocks of noise appear during playback, or there is no playback picture and the screen becomes blue.	4. <ul style="list-style-type: none"> <li>• —</li> <li>• The tape is recorded in LP mode.</li> </ul>	4. <ul style="list-style-type: none"> <li>• Clean the video heads with an optional cleaning cassette.</li> <li>• This is not a malfunction.</li> </ul>
5. A memory card cannot be played back.	5. <ul style="list-style-type: none"> <li>• The Playback Mode Switch is set to "VIDEO".</li> </ul>	5. <ul style="list-style-type: none"> <li>• Set the Playback Mode Switch to "MEMORY".</li> </ul>
6. The image on the 4:3 TV is elongated vertically (squeeze).	6. <ul style="list-style-type: none"> <li>• This occurs during recording in HD or SD mode when a tape (its erase protection tab is set to "REC") is loaded.</li> <li>• The component video cable and S-video or audio/video cable are connected simultaneously.</li> </ul>	6. <ul style="list-style-type: none"> <li>• This is not a malfunction.</li> <li>• Disconnect either of two cables.</li> </ul>
7. The screen of the LCD monitor is blackened or blocks of noise appear on its right side but ►/■ is not pressed.	7. <ul style="list-style-type: none"> <li>• The S-Video or audio/video cable is connected and "S/AV INPUT" (☞ pg. 29) is set to "ON".</li> </ul>	7. <ul style="list-style-type: none"> <li>• This is not a malfunction. After dubbing, set "S/AV INPUT" back to "OFF".</li> </ul>
8. When the screen is under direct sunlight, the screen becomes red or black for an instant.	8. <ul style="list-style-type: none"> <li>• This is not a malfunction.</li> </ul>	8. <ul style="list-style-type: none"> <li>• —</li> </ul>

## Advanced features

SYMPTOM	POSSIBLE CAUSES	CORRECTIVE ACTION
<b>9.</b> During recording, the date/time does not appear.	<b>9.</b> • "DATE/TIME" is set to "OFF".	<b>9.</b> • Set "DATE/TIME" to "ON". (☞ pg. 28, 31)
<b>10.</b> During recording, sound cannot be heard.	<b>10.</b> • The optional headphones are not connected to the headphones connector.	<b>10.</b> • Connect the optional headphones to the headphone connector. (☞ pg. 59)
<b>11.</b> Cannot record signals from a device which is connected to the i.LINK connector.	<b>11.</b> • The connected device is not compatible with this player.	<b>11.</b> • Dubbing from other devices in MPEG2 format is possible if the connected device is another same model of this unit. It is also possible to dub in MPEG2 format from a D-VHS VCR, if the source tape (D-VHS) has been originally dubbed from this digital HD player in MPEG2 format.





## Other problems

SYMPTOM	POSSIBLE CAUSES	CORRECTIVE ACTION
12. The CHARGE indicator on the AC Power Adapter/Charger does not light.	12. • The temperature of the battery is extremely high/low. • Charging is difficult in places subject to extremely high/low temperatures.	12. • To protect the battery, it is recommended to charge it in places with a temperature of 10°C to 35°C (50°F to 95°F). (☞ pg. 52)
13. "SET DATE/TIME!" appears.	13. • The built-in clock's battery has run out. • The previously set date/time is erased.	13. • Consult your nearest JVC dealer for replacement.
14. There is no picture.	14. • The player is not getting power, or some other malfunction exists.	14. • Turn the player's power off and on again. (☞ pg. 13)
15. Files stored in the memory card cannot be deleted.	15. • Files stored in the memory card are protected.	15. • Remove protection from the files stored in the memory card and delete them. (☞ pg. 24 – 25)
16. When the player is connected via the i.LINK connector, the player does not operate.	16. • The i.LINK cable was plugged/unplugged with power turned on.	16. • Turn the player's power off and on again, then operate it.
17. The rear of the LCD monitor is hot.	17. • The light used to illuminate the LCD monitor causes it to become hot.	17. • Close the LCD monitor to turn it off or set the Power Switch to "OFF", and let the unit cool down.
18. Images on the LCD monitor appear dark or whitish.	18. • In places subject to low temperature, images become dark due to the characteristics of the LCD monitor. When this happens, the displayed colors differ from those that are actually recorded. This is not a defect of the player. • When the LCD monitor's fluorescent light reaches the end of its service life, images on the LCD monitor become dark. Consult your nearest JVC dealer.	18. • Adjust the brightness and angle of the LCD monitor. (☞ pg. 14)
19. Colored bright spots appear all over the LCD monitor.	19. • The LCD monitor is made with high-precision technology. However, black spots or bright spots of light (red, green or blue) may appear constantly on the LCD monitor. These spots are not recorded on the tape. This is not due to any defect of the unit. (Effective dots: more than 99.99 %)	19. —

20. The indicators and the image color on the LCD monitor are not clear.	20. • This may occur when the surface or the edge of the LCD monitor is pressed.	20. —
21. The cassette will not load properly.	21. • The battery's charge is low.	21. • Install a fully charged battery. (☞ pg. 11, 12)
22. The memory card cannot be removed from the player.	22. —	22. • Push in the memory card a few more times. (☞ pg. 17)
23. Picture does not appear on the LCD monitor.	23. • The LCD monitor's brightness setting is too dark.	23. • Adjust the brightness of the LCD monitor. (☞ pg. 14)
24. Images on the LCD monitor are jittery.	24. • The speaker volume is too great.	24. • Turn the speaker volume down. (☞ pg. 18)
25. The LCD monitor has become dirty (ex. fingerprints).	25. —	25. • Wipe them gently with soft cloth. Wiping strongly can cause damage. (☞ pg. 55)
26. Time code does not appear.	26. • "TIME CODE" is set to "OFF".	26. • Set "TIME CODE" to "ON". (☞ pg. 28, 31)
27. An error indication (E01, E02 or E06) appears.	27. • A malfunction of some kind has occurred. In this case the player's functions become unusable.	27. • ☞ pg. 51.
28. An error indication (E03 or E04) appears.	28. • A malfunction of some kind has occurred. In this case the player's functions become unusable.	28. • ☞ pg. 51.
29. The remote control does not work.	29. • "REMOTE" is set to "OFF". • The remote control does not point at the remote sensor. • The remote control batteries are exhausted.	29. • Set "REMOTE" to "ON". (☞ pg. 28, 30) • Point at the remote sensor. (☞ pg. 39) • Replace the batteries with fresh ones. (☞ pg. 39)

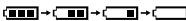

## Warning Indications

Indications	Meaning
	Displays the battery remaining power. Remaining power level: high  Remaining power level: exhausted  As the battery power comes close to nil, the battery indicator blinks. When the battery power is exhausted, power turns off automatically.
	Appears when no tape is loaded. <span style="float: right;">(☞ pg. 16)</span>
<b>CHECK TAPE'S ERASE PROTECTION TAB</b>	Appears if the erase protection tab is set to "SAVE" when the <b>REC</b> (●) Button is pressed when dubbing.
 <b>USE CLEANING CASSETTE</b>	Appears if dirt is detected on the heads during recording. Use an optional cleaning cassette.
 <b>CONDENSATION OPERATION PAUSED PLEASE WAIT</b>	Appears if condensation occurs. When this indication is displayed, wait more than 1 hour until condensation disappears.
<b>TAPE!</b>	Appears if a tape is not loaded when the <b>REC</b> (●) Button is pressed when dubbing.
<b>TAPE END</b>	Appears when the tape ends during recording or playback. <span style="float: right;">(☞ pg. 44)</span>
<b>CAN NOT PLAY BACK THIS TAPE</b>	Appears when you attempt to play back a tape that is not compatible with this player.
<b>CAN NOT DISPLAY ON LCD MONITOR IN THIS MODE</b>	Appears when dubbing a scene recorded in HD mode through the component video connectors. <span style="float: right;">(☞ pg. 35)</span>

## Warning Indications

Indications	Meaning
<b>i.LINK CONNECTION ERROR! CHECK CABLE CONNECTION</b>	Appears when an i.LINK cable is connected but not detected. Disconnect the cable once and connect it again, or disconnect other connected cables. (☞ pg. 35)
<b>TO CHANGE i.LINK OUTPUT SETTING, DISCONNECT i.LINK CABLE, FIRST</b>	Appears when you attempt to change the i.LINK output mode while an i.LINK cable is connected. (☞ pg. 35)
<b>INVALID DATA! CAN NOT INPUT</b> <b>COPY PROTECTED CAN NOT INPUT</b> <b>CAN NOT DECODE VIDEO OR AUDIO</b>	Appears when you attempt to dub signals which are copygurdred or not compatible with this player through an i.LINK cable.
<b>A. DUB ERROR!</b>	Appears if Audio Dubbing is attempted on a blank portion of a tape. (☞ pg. 42)
<b>A. DUB ERROR!</b> <b>&lt;MPEG2 RECORDED&gt;</b> <b>&lt;CANNOT DUB ON A LP RECORDED TAPE&gt;</b> <b>&lt;CANNOT DUB ON A 16bit RECORDING&gt;</b> <b>&lt;CHECK TAPE'S ERASE PROTECTION TAB&gt;</b>	<ul style="list-style-type: none"> <li>● Appears if Audio Dubbing is attempted on a tape recorded in SD or HD mode. (☞ pg. 42)</li> <li>● Appears if Audio Dubbing is attempted on a tape recorded in the LP mode. (☞ pg. 42)</li> <li>● Appears if Audio Dubbing is attempted on a tape recorded in 16-bit audio. (☞ pg. 42)</li> <li>● Appears if <b>A. DUB</b> (●) on the remote control is pressed when the erase protection tab is set to "SAVE". (☞ pg. 42)</li> </ul>

**Warning Indications**

Indications	Meaning
<b>COPYING FAILED</b>	<ul style="list-style-type: none"> <li>● Appears if dubbing of copyguarded signals is attempted while this player is being used as a recorder.</li> <li>● Appears in the following cases when dubbing still images from a tape to a memory card:               <ul style="list-style-type: none"> <li>– when no memory card is loaded.</li> <li>– when the memory card's memory is full.</li> <li>– when the memory card is not formatted.</li> <li>– when a write-protected SD Memory Card is loaded. (☞ pg. 38)</li> </ul> </li> </ul>
<b>MEMORY CARD!</b>	Appears if there is no memory card loaded when you attempt to access data on a memory card.
<b>PLEASE FORMAT</b>	Appears when there is a problem with a memory card and its memory is corrupt, or it has not been initialized. Initialize the memory card. (☞ pg. 27)
<b>NO IMAGES STORED</b>	Appears if there are no image files stored in the memory card when you attempt memory card playback.
<b>CARD ERROR!</b>	Appears when the player does not recognize the loaded memory card. Remove the memory card once and insert it again. Repeat these procedures until no indication appears. If the indication still appears, the memory card is corrupted.
<b>UNSUPPORTED FILE!</b>	Appears when playing back a file that is not compatible with DCF or a file with a size that is not compatible with this player.
<b>CHECK CARD'S WRITE PROTECTION SWITCH</b>	<ul style="list-style-type: none"> <li>● Appears when you attempt to dub digital still images when the write protection tab on the SD Memory Card is set to the "LOCK" position.</li> <li>● Appears when you attempt MEMORY SELECT menu operation with a write-protected SD Memory Card loaded.</li> </ul>
<b>E01, E02 or E06 UNIT IN SAFEGUARD MODE REMOVE AND REATTACH BATTERY</b>	The error indications (E01, E02 or E06) show what type of malfunction has occurred. When an error indication appears, the player turns off automatically. Remove the power supply (battery, etc.) and wait a few minutes for the indication to clear. When it does, you can resume using the player. If the indication remains, consult your nearest JVC dealer.
<b>E03 or E04 UNIT IN SAFEGUARD MODE EJECT AND REINSERT TAPE</b>	The error indications (E03 or E04) show what type of malfunction has occurred. When an error indication appears, the player turns off automatically. Eject the cassette once and re-insert it, then check if the indication clears. When it does, you can resume using the player. If the indication remains, consult your nearest JVC dealer.

### When using the AC Power Adapter/Charger in areas other than the USA

- The provided AC Power Adapter/Charger features automatic voltage selection in the AC range from 110 V to 240 V.

#### USING HOUSEHOLD AC PLUG ADAPTER

In case of connecting the unit's power cord to an AC wall outlet other than American National Standard C73 series type use an AC plug adapter, called a "Siemens Plug", as shown.

For this AC plug adapter, consult your nearest JVC dealer.

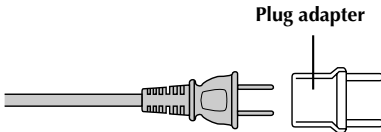

### Caution on Replaceable lithium battery

The battery used in this device may present a fire or chemical burn hazard if mistreated.

Do not recharge, disassemble, heat above 100°C (212°F) or incinerate.

Replace battery with Panasonic (Matsushita Electric), Sanyo, Sony or Maxell CR2025.

Danger of explosion or Risk of fire if the battery is incorrectly replaced.

- Dispose of used battery promptly.
- Keep away from children.
- Do not disassemble and do not dispose of in fire.

### Battery Packs

The supplied battery pack is a lithium-ion battery. Before using the supplied battery pack or an optional battery pack, be sure to read the following cautions:

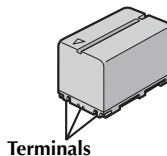

#### 1. To avoid hazards...

- ... do not burn.
- ... do not short-circuit the terminals. When transporting, make sure the provided battery cap is attached to the battery. If the battery cap is misplaced, carry the battery in a plastic bag.
- ... do not modify or disassemble.
- ... do not expose the battery to temperatures exceeding 60°C (140°F), as this may cause the battery to overheat, explode or catch fire.
- ... use only specified chargers.

#### 2. To prevent damage and prolong service life...

- ... do not subject to unnecessary shock.
- ... charge in an environment where temperatures are within the tolerances shown in the chart below. This is a chemical reaction type battery — cooler temperatures impede

- chemical reaction, while warmer temperatures can prevent complete charging.
- ... store in a cool, dry place. Extended exposure to high temperatures will increase natural discharge and shorten service life.
- ... fully charge and then fully discharge the battery every 6 months when storing the battery pack over a long period time.
- ... remove from charger or powered unit when not in use, as some machines use current even when switched off.

#### NOTES:

- It is normal for the battery pack to be warm after charging, or after use.
- Temperature Range Specifications**
- Charging.....10°C to 35°C (50°F to 95°F)  
 Operation.....0°C to 40°C (32°F to 104°F)  
 Storage .....-20°C to 50°C (-4°F to 122°F)
- Recharging time is based on room temperature of 20°C (68°F).
  - The lower the temperature, the longer recharging takes.

### Cassettes

To properly use and store your cassettes, be sure to read the following cautions:

#### 1. During use...

- ... make sure the cassette bears the Mini DV mark.
- ... be aware that recording onto prerecorded tapes automatically erases the previously recorded video and audio signals.
- ... make sure the cassette is positioned properly when inserting.
- ... do not load and unload the cassette repeatedly without allowing the tape to run at all. This slackens the tape and can result in damage.
- ... do not open the front tape cover. This exposes the tape to fingerprints and dust.

#### 2. Store cassettes...

- ... away from heaters or other heat sources.
- ... out of direct sunlight.
- ... where they won't be subject to unnecessary shock or vibration.
- ... where they won't be exposed to strong magnetic fields (such as those generated by motors, transformers or magnets).
- ... vertically, in their original cases.

## Memory Cards

To properly use and store your memory cards, be sure to read the following cautions:

### 1. During use...

- ... make sure the memory card bears the SD or MultiMediaCard mark.
- ... make sure the memory card is positioned properly when inserting.

### 2. While the memory card is being accessed (during recording, playback, deletion, initialization, etc.)...

- ... never unload the memory card and never turn off the player.

### 3. Store memory cards...

- ... away from heaters or other heat sources.
- ... out of direct sunlight.
- ... where they won't be subject to unnecessary shock or vibration.
- ... where they won't be exposed to strong magnetic fields (such as those generated by motors, transformers or magnets).

## LCD Monitor

### 1. To prevent damage to the LCD monitor, DO NOT...

- ... push it strongly or apply any shocks.
- ... place the player with the LCD monitor on the bottom.

### 2. To prolong service life...

- ... avoid rubbing it with coarse cloth.

### 3. Be aware of the following phenomena for LCD monitor use.

#### These are not malfunctions:

- While using the player, the surface around the LCD monitor and/or the back of the LCD monitor may heat up.
- If you leave power on for a long time, the surface around the LCD monitor becomes hot.

## Main Unit

### 1. For safety, DO NOT...

- ... open the player's chassis.
- ... disassemble or modify the unit.
- ... short-circuit the terminals of the battery pack. Keep it away from metallic objects when not in use.
- ... allow inflammables, water or metallic objects to enter the unit.
- ... remove the battery pack or disconnect the power supply while the power is on.
- ... leave the battery pack attached when the player is not in use.

### 2. Avoid using the unit...

- ... in places subject to excessive humidity or dust.

... in places subject to soot or steam such as near a cooking stove.

... in places subject to excessive shock or vibration.

... near a television set.

... near appliances generating strong magnetic or electric fields (speakers, broadcasting antennas, etc.).

... in places subject to extremely high (over 40°C or 104°F) or extremely low (under 0°C or 32°F) temperatures.

### 3. DO NOT leave the unit...

... in places of over 50°C (122°F).

... in places where humidity is extremely low (below 35%) or extremely high (above 80%).

... in direct sunlight.

... in a closed car in summer.

... near a heater.

### 4. To protect the unit, DO NOT...

... allow it to become wet.

... drop the unit or strike it against hard objects.

... subject it to shock or excessive vibration during transportation.

... carry it by holding the LCD monitor.

... swing it excessively when using the shoulder strap.

### 5. Dirty heads can cause the following problems:



- No picture during playback.
- Blocks of noise appear during playback.
- During playback, the Head Clog Warning indicator "⊗" appears.

In such cases, use an optional cleaning cassette.

Insert it and play back. If the cassette is used more than once consecutively, damage to the video heads may result. After the player plays back for about 20 seconds, it stops automatically. Also refer to the cleaning cassette's instructions.

If, after using the cleaning cassette, the problems still exist, consult your nearest JVC dealer.

Mechanical moving parts used to move the video heads and video tape tend to become dirty and worn out over time. In order to maintain a clear picture at all times, periodic check-ups are recommended after using the unit for about 1,000 hours. For periodic check-ups please consult your nearest JVC dealer.

**About moisture condensation...**

- You have observed that pouring a cold liquid into a glass will cause drops of water to form on the glass' outer surface. This same phenomenon occurs on the head drum of a player when it is moved from a cool place to a warm place, after heating a cold room, under extremely humid conditions or in a place directly subjected to the cool air from an air conditioner.
- Moisture on the head drum can cause severe damage to the video tape, and can lead to internal damage to the player itself.

**Serious malfunctioning**

If malfunctioning occurs, stop using the unit immediately and consult your local JVC dealer.

The player is a microcomputer-controlled device. External noise and interference (from a TV, a radio, etc.) might prevent it from functioning properly. In such cases, first disconnect its power supply unit (battery pack, AC Power Adapter/Charger, etc.) and wait a few minutes and then reconnect it and proceed as usual from the beginning.

**Declaration of Conformity**

Model Number : CU-VH1U  
 Trade Name : JVC  
 Responsible party : JVC AMERICAS CORP.  
 Address : 1700 Valley Road Wayne,  
 N J 07470  
 Telephone Number : 973-317-5000  
 This device complies with Part 15 of FCC Rules. Operation is subject to the following two conditions: (1) This device may not cause harmful interference, and (2) this device must accept any interference received, including interference that may cause undesired operation.

Changes or modifications not approved by JVC could void the user's authority to operate the equipment. This equipment has been tested and found to comply with the limits for a Class B digital device, pursuant to Part 15 of the FCC Rules. These limits are designed to provide reasonable protection against harmful interference in a residential installation. This equipment generates, uses, and can radiate radio frequency energy and, if not installed and used in accordance with the instructions, may cause harmful interference to radio communications. However, there is no guarantee that interference will not occur in a particular installation. If this equipment does cause harmful interference to radio or television reception, which can be determined by turning the equipment off and on, the user is encouraged to try to correct the interference by one or more of the following measures:

- Reorient or relocate the receiving antenna.
- Increase the separation between the equipment and receiver.
- Connect the equipment into an outlet on a circuit different from that to which the receiver is connected.
- Consult the dealer or an experienced radio/ TV technician for help.

This Class B digital apparatus complies with Canadian ICES-003.

Cet appareil numérique de la classe B est conforme à la norme NMB-003 du Canada.

## After Use

- 1 Turn off the player.
- 2 Slide and hold **OPEN/EJECT** in the direction of the arrow, then pull the cassette holder cover open until it locks. The cassette holder opens automatically. Remove the cassette.
- 3 Press "PUSH HERE" to close the cassette holder.
  - Once the cassette holder is closed, it recedes automatically. Wait until it recedes completely before closing the cassette holder cover.
- 4 Slide **BATT.RELEASE** ① and remove the battery pack ② ③.

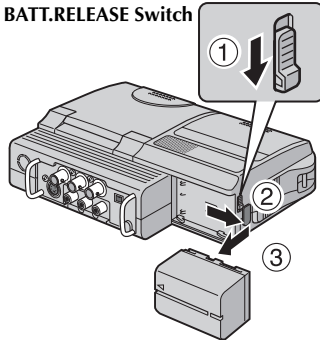
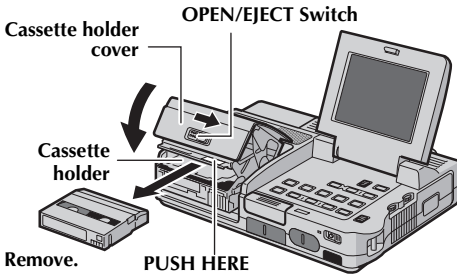

## Cleaning The Player

- 1 To clean the exterior, wipe gently with a soft cloth. Put the cloth in diluted mild soap and wring it well to wipe off heavy dirt. Then wipe again with a dry cloth.
- 2 Press the Monitor Opening Button and open the LCD monitor. Wipe gently with a soft cloth. Be careful not to damage the monitor. Close the LCD monitor.

### NOTES:

- Avoid using strong cleaning agents such as benzine or alcohol.
- Cleaning should be done only after the battery pack has been removed or other power units have been disconnected.
- When using a cleaner or chemically treated cloth refer to the cautions of each product.

## Player

### For General

<b>Power supply</b>	: DC 6.3 V (Using AC Power Adapter/Charger) DC 7.2 V (Using battery pack)
<b>Power consumption</b>	: Approx. 6.3 W (DV)/6.9 W (HD, SD)
<b>Dimensions (W x H x D)</b>	: 211 mm x 52 mm x 154 mm (8-5/16" x 2-1/16" x 6-1/8") (with the LCD monitor closed)
<b>Weight</b>	: Approx. 1005 g (2.3 lbs) (without cassette, memory card and battery) Approx. 1145 g (2.6 lbs) (incl. cassette, memory card and battery)
<b>Operating temperature</b>	: 0°C to 40°C (32°F to 104°F)
<b>Operating humidity</b>	: 35% to 80%
<b>Storage temperature</b>	: -20°C to 50°C (-4°F to 122°F)
<b>LCD monitor</b>	: 3.5" diagonally measured, LCD panel/TFT active matrix system
<b>Speaker</b>	: Monaural

### For Video Playback

<b>Signal format</b>	: NTSC standard
<b>Cassette</b>	: Mini DV cassette
<b>Tape speed</b>	: SP: 18.8 mm/s LP: 12.5 mm/s
<b>Maximum recording time (using 80 min. cassette)</b>	: SP: 80 min. LP: 120 min.

### For D.S.C. Playback

<b>Storage media</b>	: SD Memory Card/MultiMediaCard
<b>Compression system</b>	: JPEG (compatible)
<b>File size</b>	: 3 modes (DV: 640 x 480 pixels/SD: 848 x 480 pixels/HD:1280 x 720 pixels)



**For Connectors****S2**

<b>S-Video input</b>	:	Y: 0.8 V to 1.2 V (p-p), 75 $\Omega$ , analog C: 0.2 V to 0.4 V (p-p), 75 $\Omega$ , analog
<b>S-Video output</b>	:	Y: 1.0 V (p-p), 75 $\Omega$ , analog C: 0.29 V (p-p), 75 $\Omega$ , analog

**VIDEO**

<b>Video input</b>	:	Y: 0.8 V to 1.2 V (p-p), 75 $\Omega$ , analog
<b>Video output</b>	:	Y: 1.0 V (p-p), 75 $\Omega$ , analog

**AUDIO**

<b>Audio input</b>	:	300 mV (rms), 50 k $\Omega$ , analog, stereo
<b>Audio output</b>	:	300 mV (rms), 1 k $\Omega$ , analog, stereo

**Headphone output** : Stereo

**Microphone input** : Stereo

**i.LINK**

**Input/output** : 4-pin, IEEE 1394 compliant

**USB** : 5-pin

**Y/Pb/Pr output** : Y: 1.0 V (p-p), 75  $\Omega$ , analog  
Pb: 0.7 V (p-p), 75  $\Omega$ , analog  
Pr: 0.7 V (p-p), 75  $\Omega$ , analog

**AC Power Adapter/Charger****For General****Power requirement**

<b>U.S.A. and Canada</b>	:	AC 120 V $\sim$ , 60 Hz
<b>Other countries</b>	:	AC 110 V to 240 V $\sim$ , 50 Hz/60 Hz

**Power consumption** : 23 W

**Output**

<b>Charge</b>	:	DC 7.2 V  , 1.2 A
<b>VTR</b>	:	DC 6.3 V  , 1.8 A

*Specifications shown are for SP mode unless otherwise indicated. E & O.E. Design and specifications subject to change without notice.*

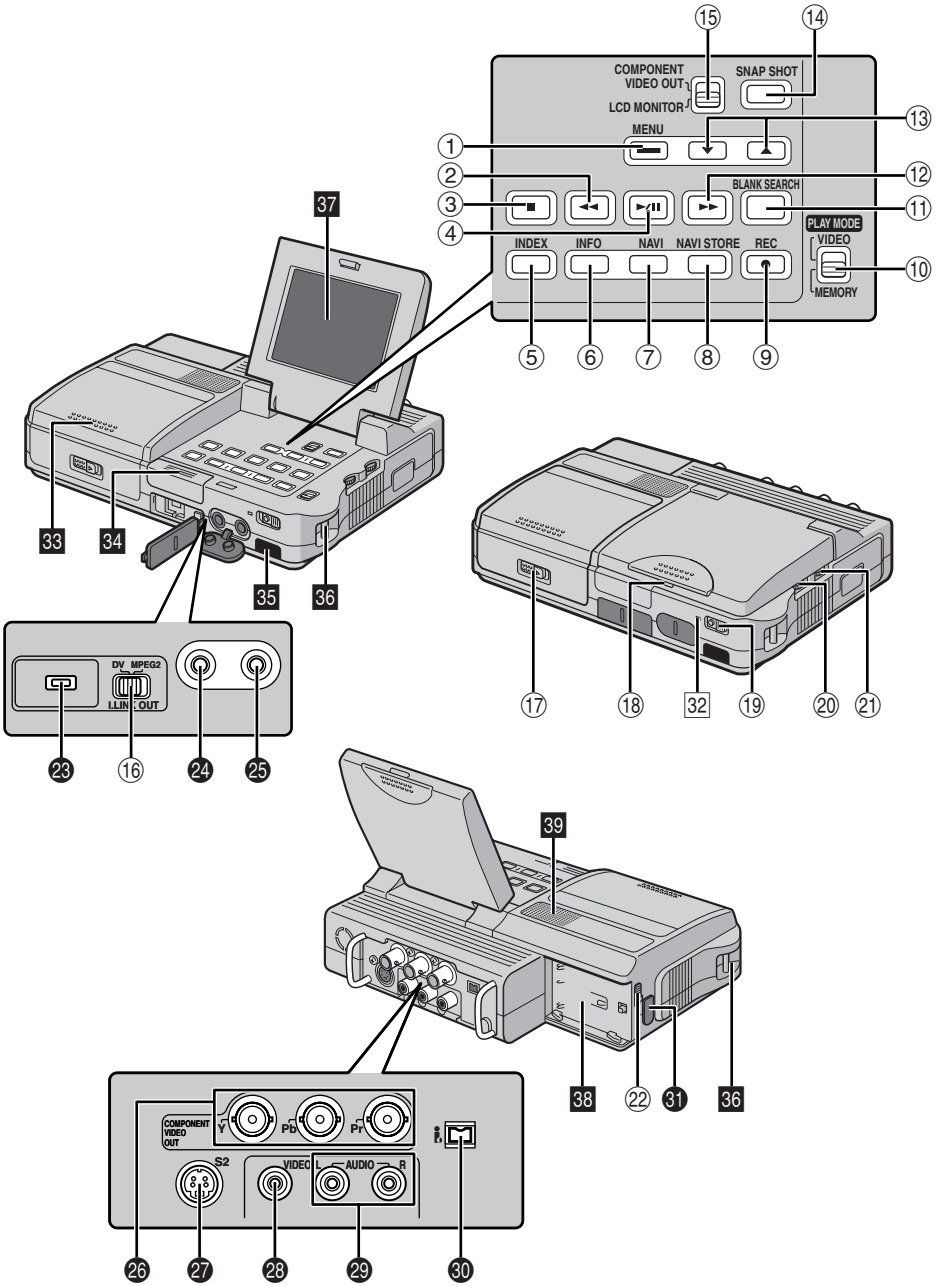

## Controls

- ① Menu Button [MENU] (☞ pg. 28)
- ② Rewind Button [◀◀] (☞ pg. 18)
- ③ Stop Button [■] (☞ pg. 18)
- ④ Play/Pause Button [▶/⏸] (☞ pg. 18)
- ⑤ Index Button [INDEX] (☞ pg. 23)
- ⑥ Information Button [INFO] (☞ pg. 23)
- ⑦ Navigation Button [NAVI] (☞ pg. 32)
- ⑧ Thumbnail Storing Button [NAVI STORE] (☞ pg. 32)
- ⑨ Recording Start/Stop Button [REC (●)] (☞ pg. 34)
- ⑩ Playback Mode Switch [VIDEO/MEMORY] (☞ pg. 13)
- ⑪ Blank Search Button [BLANK SEARCH] (☞ pg. 19)
- ⑫ Fast-Forward Button [▶▶] (☞ pg. 18)
- ⑬ ▲▼ Button (☞ pg. 15, 18)
- ⑭ Snapshot Button [SNAP SHOT] (☞ pg. 38)
- ⑮ Video Output Mode Switch [COMPONENT VIDEO OUT/LCD MONITOR] (☞ pg. 13, 34)
- ⑯ i.LINK Output Select Switch [DV/MPEG2] (☞ pg. 35)
- ⑰ Cassette Open/Eject Switch [OPEN/EJECT] (☞ pg. 16)
- ⑱ Monitor Opening Button (☞ pg. 14)
- ⑲ Power Switch [ON, OFF] (☞ pg. 13)
- ⑳ Speaker/Headphone Volume Control [VOLUME +, -] (☞ pg. 18)
- ㉑ LCD Monitor Brightness Control [BRIGHT +, -] (☞ pg. 14)
- ㉒ Battery Release Switch [BATT.RELEASE] (☞ pg. 11)

## Connectors

The connectors are located beneath the covers.

- ㉓ **USB (Universal Serial Bus) Connector** (☞ pg. 43)
- ㉔ **Headphone Connector** [⌋] (☞ pg. 9, 42)  
No sound is output from the speaker when headphones are connected to this connector.
- ㉕ **Microphone connector** [MIC] (☞ pg. 9)  
Open the connector cover, and attach the optional microphone.
- ㉖ **Component Video Connectors** [Y/Pb/Pr] (☞ pg. 20)
- ㉗ **S-Video connector** [S2] (☞ pg. 20, 34)
- ㉘ **Video Connector** [VIDEO] (☞ pg. 20, 34)
- ㉙ **Audio Connectors** [AUDIO (L/R)] (☞ pg. 20, 34, 42)
- ㉚ **Digital Video Connector** [i] (i.Link\*) (☞ pg. 35, 36, 43)  
\* "i." refers to the IEEE1394-1995 industry specification and extensions thereof. The logo is used for products compliant with the i.Link standard.
- ㉛ **DC Input Connector** [DC] (☞ pg. 11, 12)

## Indicators

- ㉜ **Power Lamp**

## Other Parts

- ㉝ **Cassette Holder Cover** (☞ pg. 16)
- ㉞ **Card Cover** [MEMORY CARD] (☞ pg. 17)
- ㉟ **Remote Sensor** (☞ pg. 39)
- ㊱ **Shoulder Strap Eyelet** (☞ pg. 9)
- ㊲ **LCD Monitor** (☞ pg. 14)
- ㊳ **Battery Pack Mount** (☞ pg. 11)
- ㊴ **Speaker** (☞ pg. 18)

## LCD Monitor Indications

## During D.S.C. Playback

### During Video Playback

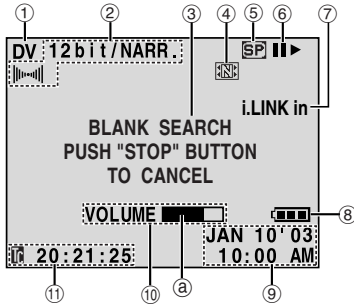



- ① **Video Playback Mode Indicator** (☞ pg. 37)
- ② **Sound Mode Indicator** (☞ pg. 29)
- ③ **Blank Search Indicator** (☞ pg. 19)
- ④ **Thumbnail Storing Indicator** (☞ pg. 32)  
(Appears while the captured image is being stored as a thumbnail image in the memory card.)
- ⑤ **Tape Speed** (☞ pg. 29)
- ⑥ **Playback Control Indicators**
  - ▶▶▶ : Fast-Forward/Shuttle Search
  - ◀◀◀ : Rewind/Shuttle Search
  - || : Pause
  - ▶|| : Forward Frame-By-Frame Playback/Slow-Motion
  - ◀|| : Reverse Frame-By-Frame Playback/Slow-Motion
  - : Audio Dubbing
  - || : Audio Dubbing Pause  
(Appear while a tape is running.)
- ⑦ **Input Mode Indicator** (☞ pg. 34, 36)
- ⑧ **Battery Indicator** (☞ pg. 49)
- ⑨ **Date/Time** (☞ pg. 31)
- ⑩ **VOLUME : Volume Level Indicator (Speaker or headphone)** (☞ pg. 18)  
(The level indicator @ moves.)
- **BRIGHT +, - : Brightness Control Indicator** (☞ pg. 14)  
(The level indicator @ moves.)
- ⑪ **Time Code\*** (☞ pg. 31)

\* This code is to confirm the location of the recorded scene on the tape during playback.

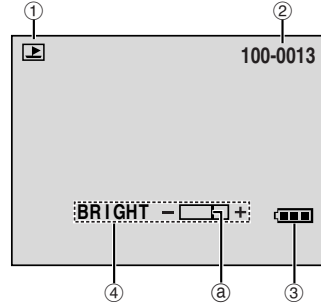
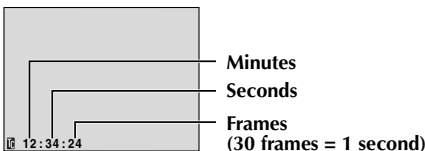
#### Display



- ① **Operation Mode Indicator** (☞ pg. 23)
- ② **Folder/File Number** (☞ pg. 23)
- ③ **Battery Indicator** (☞ pg. 49)
- ④ **Brightness Control Indicator** (☞ pg. 14)  
(The level indicator @ moves.)

<b>A</b>		<b>M</b>	
AC Power Adapter/Charger .....	11, 12	Memory Card .....	17, 53
Audio Dubbing .....	42	Menu Screen	
Auto Playback Of Images .....	22	D.S.C. Playback .....	23 – 27
<b>B</b>		DISPLAY .....	31
Battery Pack .....	11, 12, 52	SYSTEM .....	30
Beep (BEEP) .....	30	VIDEO .....	29
Blank search .....	19	MultiMediaCard .....	17, 53
Brightness Adjustment Of The Display .....	14	<b>N</b>	
<b>C</b>		Navigation (NAVIGATION) .....	32
Changing The Menu Settings .....	28	<b>P</b>	
Channels (Left/Right) .....	29	Picture Quality (QUALITY) .....	30
Charging The Battery Pack .....	11	Playback Mode Switch Position .....	13
Cleaning The Player .....	55	Playback sound (SOUND MODE, NARRATION) .....	29
Clock adjustment (CLOCK ADJ.) .....	15	Playback Special Effects .....	41
Component video output setting (Y/Pb/Pr) .....	20	Playback Zoom .....	41
Connections		Power Switch Position .....	13
Charging .....	11	Protecting Files (PROTECT) .....	24
Dubbing .....	34 – 38	Provided Accessories .....	7
To A PC .....	43	<b>R</b>	
To A TV Or VCR .....	20	Recording Mode (REC MODE) .....	29
<b>D</b>		Recording Time	
Date/Time		Tape .....	16
Display (DATE/TIME) .....	31	Record-Standby .....	34
Settings .....	15	Remaining Power Level .....	49
DCF (Design rule for Camera File system) .....	22	Remote Control .....	39
Deleting Files (DELETE) .....	25	Remote control setting (REMOTE) .....	30
Deleting thumbnail images (NAVI.DEL.) .....	29	Resetting Menu Settings (RESET) .....	30
Display .....	31	Resetting The File Name .....	26
DPOF Setting (Digital Print Order Format) .....	26, 27	Rewind The Tape .....	18
Dubbing .....	34 – 38	<b>S</b>	
Dubbing from tape to memory card (    COPY) .....	29, 38	SD Memory Card .....	17, 53
<b>E</b>		Shuttle Search .....	19
Erase Protection .....	16, 17	Slow-Motion Playback .....	40
<b>F</b>		Sound Mode (SOUND MODE) .....	29
Fast-Forward The Tape .....	18	Speaker Volume .....	18
Frame-By-Frame Playback .....	40	Special Effects (EFFECT)	
<b>I</b>		Classic Film (CLASSIC FILM) .....	41
i.LINK output setting (i.LINK OUT) .....	30	Monotone (MONOTONE) .....	41
Index Playback Of Files .....	23	Sepia (SEPIA) .....	41
Indications on the LCD Monitor .....	60	Strobe (STROBE) .....	41
Initializing A Memory Card (FORMAT) .....	27	Specifications .....	56, 57
<b>L</b>		Still Playback .....	18
Loading A Cassette .....	16	S-Video output setting (S/VIDEO) .....	30
Loading A Memory Card .....	17	S-Video/AV input (S/AV INPUT) .....	29, 34
		<b>T</b>	
		Time Code (TIME CODE) .....	31
		<b>U</b>	
		Unloading A Cassette .....	16
		Unloading A Memory Card .....	17





